

CARCASSONNE TILE DISPENSER



TECHNICAL SPECS

1x tile dispenser, with shutter closure and upper tiles stopper. "Dispenser" mechanism to pick tiles from the lower part. Can hold up to 84 tiles lxl 4.5 x 4.5 cm 2mm thick (Carcassonne tiles). 1x Contenitore per tessere, con chiusura a saracinesca e fermo superiore. Meccanismo "a dispenser" per presa delle tessere dalla parte inferiore. Spazio fino a 84 tessere da 4,5 x 4,5 cm e 2mm di spessore (tessere Carcassonne).



* Any doubt?
Check out our FAQ page
or download the digital
version of the instructions
on our website!

All trademarks and copyrights are the property of their respective owners.
This product is not a toy. Contains small parts that can be swallowed or inhaled. 14+



CARCASSONNE TILE DISPENSER

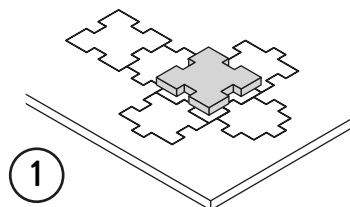
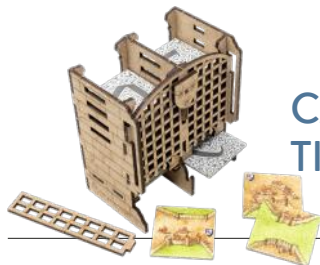

1

Gently take off
all the pieces.
Stacca delicatamente
dal foglio tutti i pezzi.

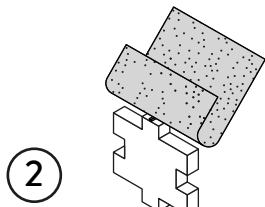

2

If necessary, use sand paper to
smoothen the borders.
Se necessario rifila con carta
vetrata per legno eventuali
imperfezioni dei pezzi.

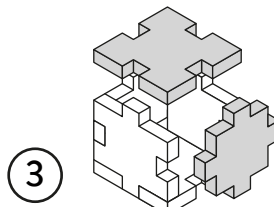

3

Get familiar with
all the pieces
and check the correct assembly
sequence.
Prendi familiarità con tutti
i pezzi, per assicurarti
che la sequenza di assemblaggio sia
corretta.

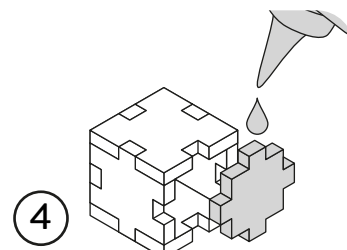

4

Once verified the correct assembly
sequence, just add a small quantity
of PVA glue on every joint.
Dopo aver verificato
la sequenza di assemblaggio
aggiungi una piccola quantità di
colla vinilica su tutti
gli incastri per garantirne
la durata nel tempo.

INSTRUCTIONS

NOTE
While assembling remember that the
engraved sides must be facing outwards.
Mentre assembli ricorda che i lati incisi vanno
rivolti verso l'esterno.

A

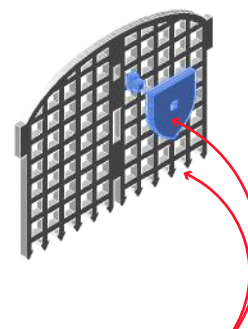
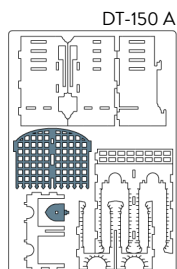
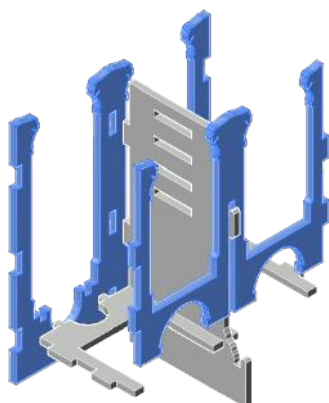
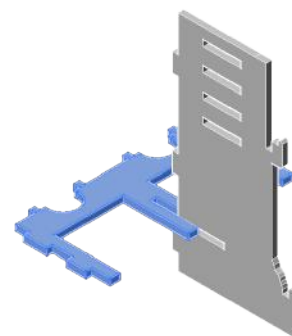
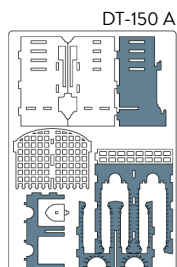

NOTE: Engraved side. Lato Inciso

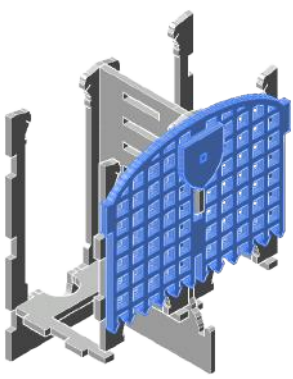

NOTE: Hang the gate without gluing it.
Appendi il cancello senza incollarlo.

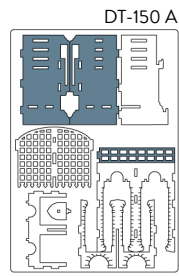

DT-150 A

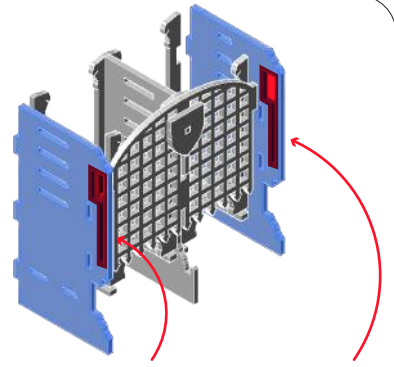

NOTE: Don't glue the area marked in red,
the gate must be able to slide in the guides.
Non incollare la zona segnalata in rosso, il
cancello deve poter scorrere nelle guide.

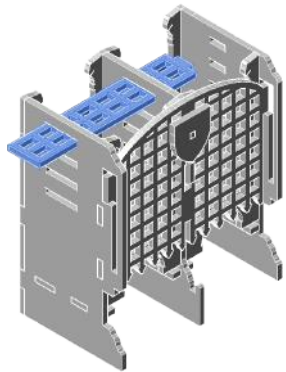

NOTE: Don't use glue; this piece can be
removed during the game. Non incollare,
pezzo rimovibile durante il gioco.

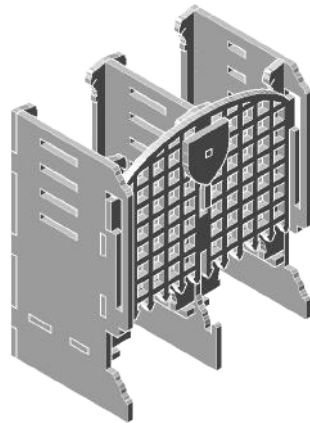

Open. Aperto.

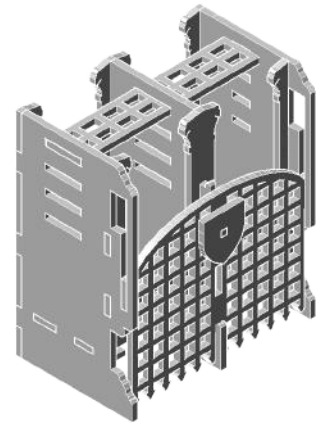

Closed. Chiuso.



Non-recyclable waste.
Smaltire i materiali di scarto nell'indifferenziata.

All trademarks and copyrights are the property of their respective owners.
This product is not a toy. Contains small parts that can be swallowed or inhaled. 14+