

## ORGANIZER - COMPATIBLE WITH GALAXY TRUCKER (BASE GAME OR WITH KEEP ON TRUCKING EXP)

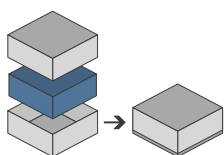

Designed to fit into the game box. Once inserted all the components from base and expansion, lid will sit by 1cm approximately. To have a flush closure store expansion boards elsewhere. Progettato per inserirsi all'interno della scatola di gioco. Inserendo tutti i componenti di gioco base ed esp la scatola alzerà di 1cm circa. Per una chiusura a filo riporre altrove le mappe dell'espansione.\*



Designed for both sleeved and unsleeved cards. Adatto sia per carte imbustate che non imbustate\*

26.3 x 18.2 x 4.5 cm



Size of assembled organiser  
Dimensioni organizer assemblato

### ORGANIZER CAPACITY

2x starship tiles trays; 1x resource holder for cargo and batteries; 1x card holder, with dedicated slots; 1x setup box, with dedicated slots; 2x credit trays, with slots for each value; 1x crew tray. 2x vassoi per tessere astronave; 1x portarisorsa per cargo e batterie; 1x portacarte, con slot dedicati; 1x box setup, con slot dedicati; 2x portamonete, con slot per ogni taglio; 1x vassoio per equipaggio.



\* Any doubt?  
Check out our FAQ page or download the digital version of the instructions on our website!

All trademarks and copyrights are the property of their respective owners.  
This product is not a toy. Contains small parts that can be swallowed or inhaled. 14+

ORGANIZER - COMPATIBLE WITH  
**GALAXY TRUCKER**  
 (BASE GAME OR WITH KEEP ON TRUCKING EXP)



## TUTORIAL - THE DICETROYERS DICE!

Among the pieces to assemble, you'll find a dice. This is not part of the organizer, but it can be a good starting point to practice!

Tra i materiali da assemblare troverai un dado. Questo componente non fa parte dell'organizer, né del gioco, ma è un ottimo punto di partenza per fare un po' di pratica.

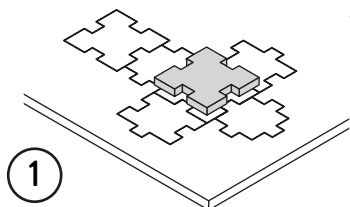

1

Gently take off  
all the pieces.  
Stacca delicatamente  
dal foglio tutti i pezzi.

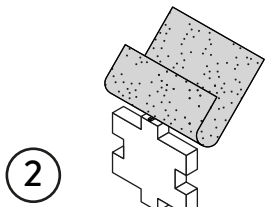

2

If necessary, use sand paper to  
smoothen the borders.  
Se necessario rifila con carta  
vetrata per legno eventuali  
imperfezioni dei pezzi.

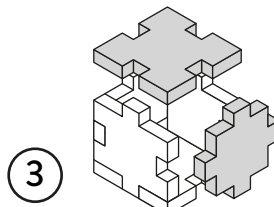

3

Get familiar with  
all the pieces  
and check the correct assembly  
sequence.  
Prendi familiarità con tutti  
i pezzi, per assicurarti  
che la sequenza di assemblaggio sia  
corretta.

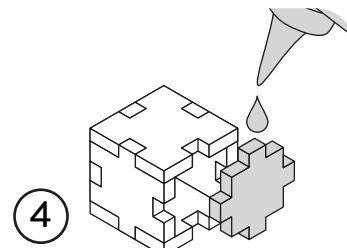

4

Once verified the correct assembly  
sequence, just add a small quantity  
of PVA glue on every joint.  
Dopo aver verificato  
la sequenza di assemblaggio  
aggiungi una piccola quantità di  
colla vinilica su tutti  
gli incastri per garantirne  
la durata nel tempo.

## INSTRUCTIONS

A



DT-143A

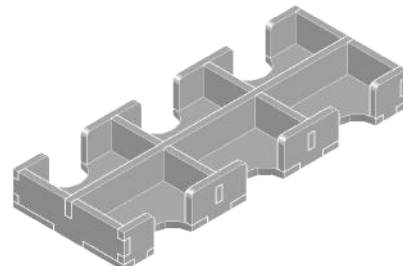
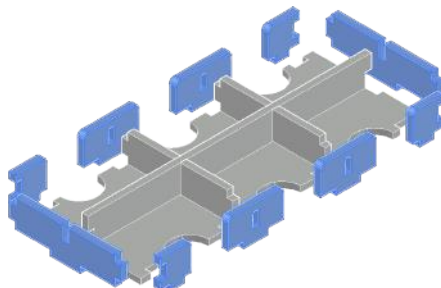
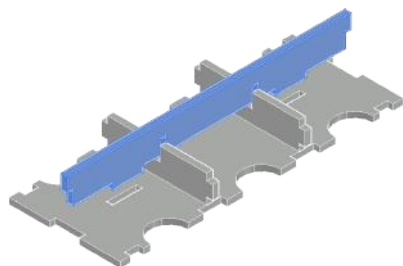
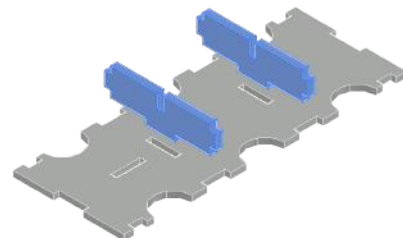
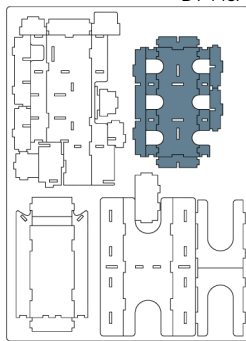

B



DT-143A

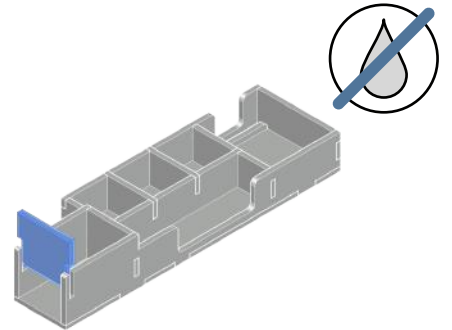
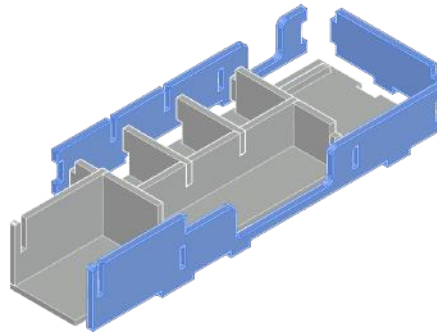
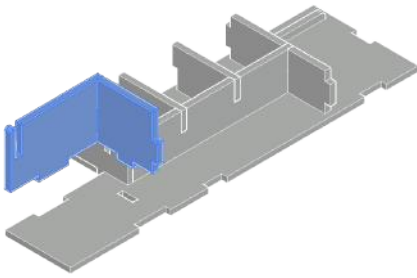
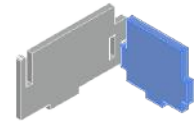
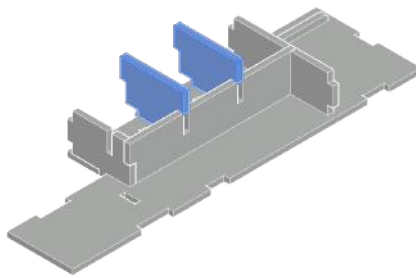
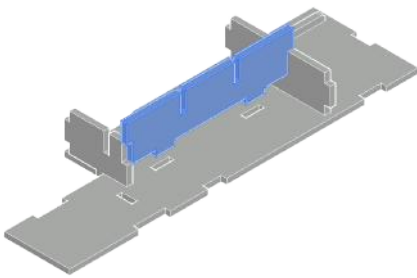
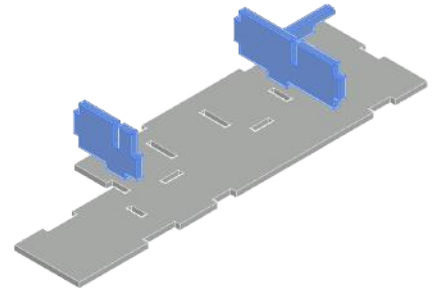
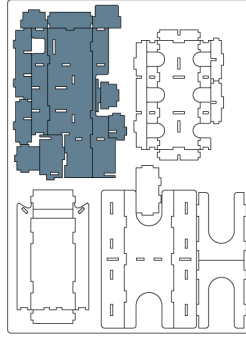

NOTE: Don't use glue on this joint; this piece can be removed during the game. Non usare colla su questo incastro, pezzo rimovibile durante il gioco.

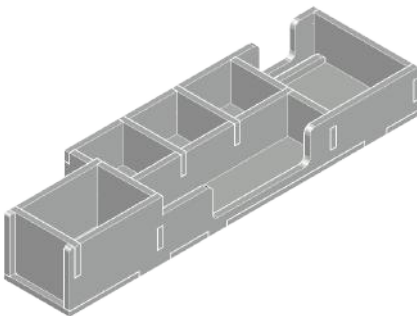

C



DT-143A

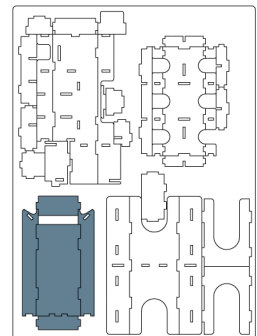

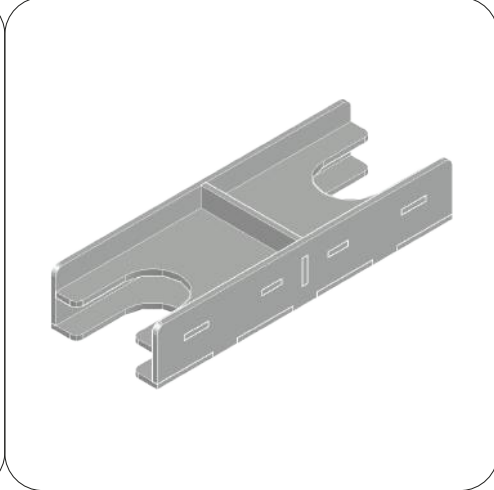
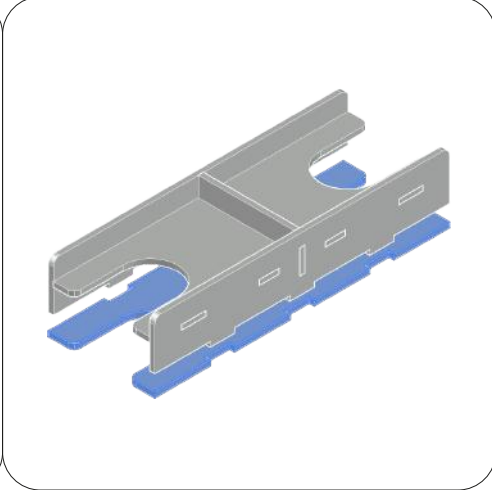
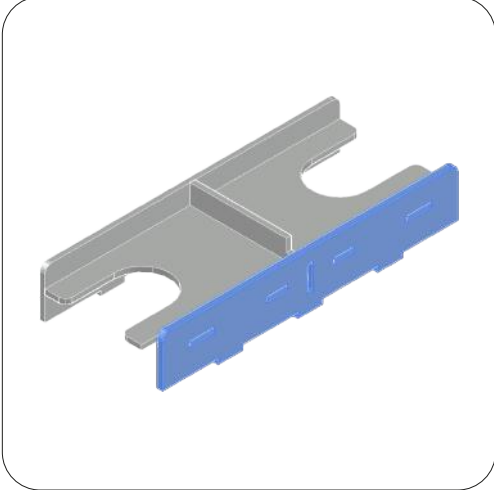
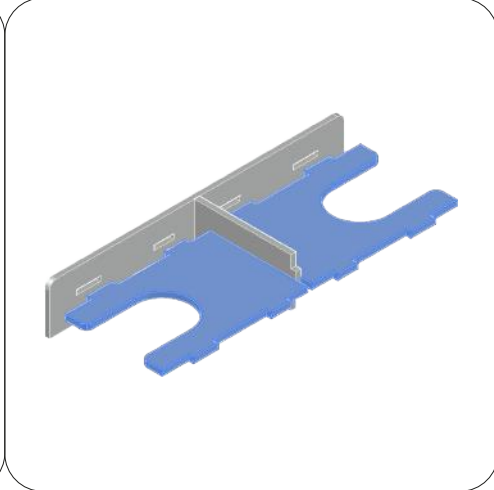
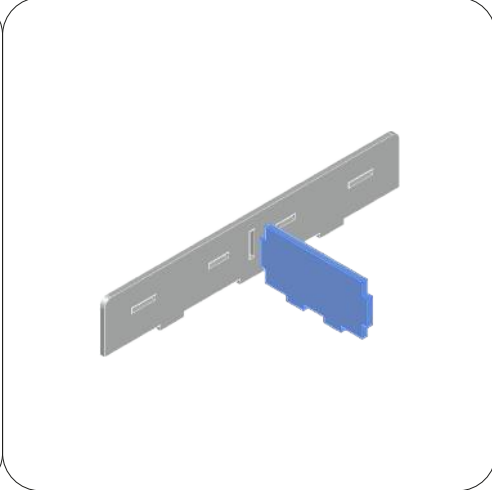
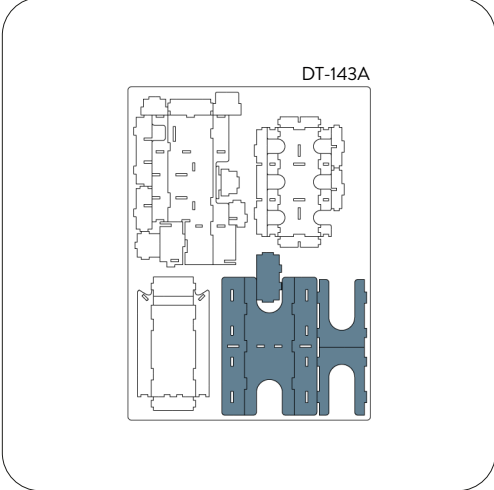
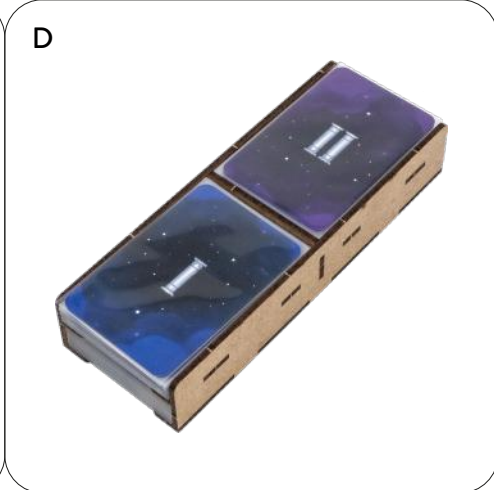
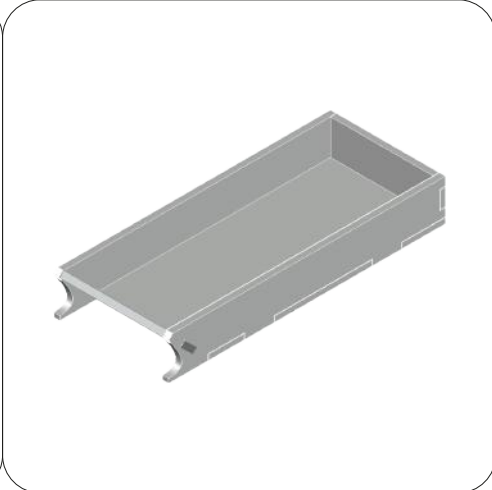
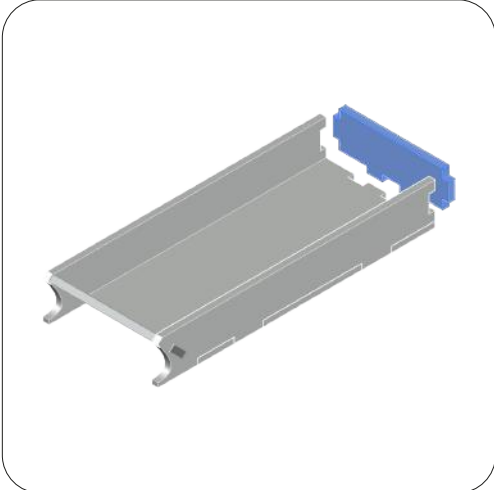
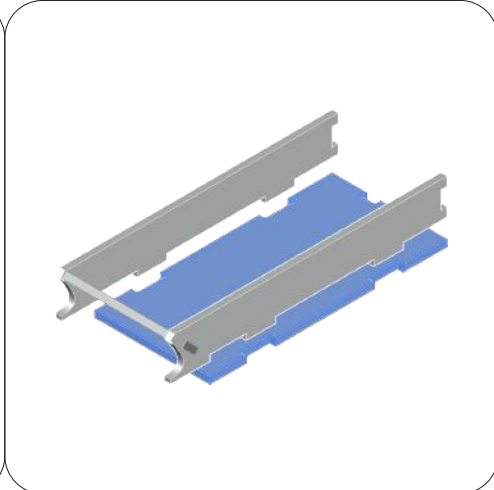
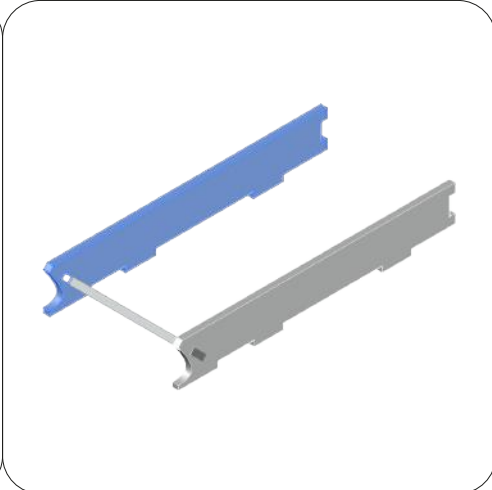
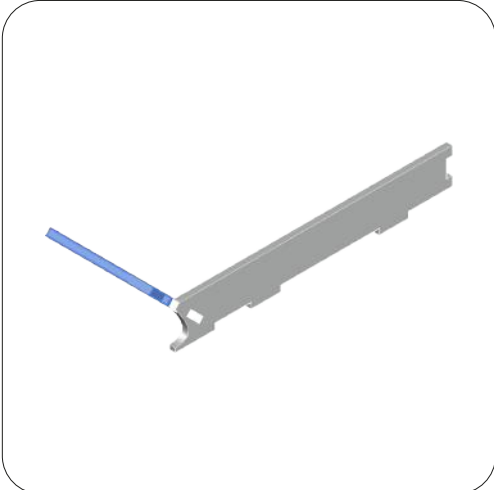

E



DT-143B

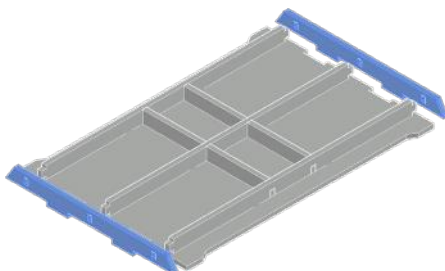
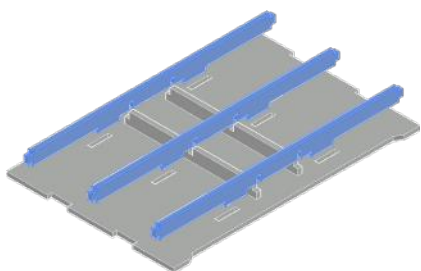
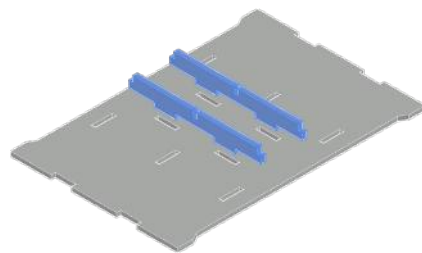
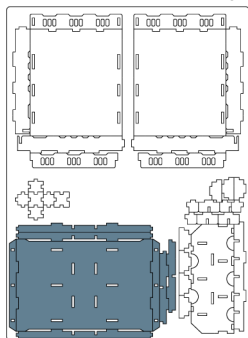

F



DT-143B

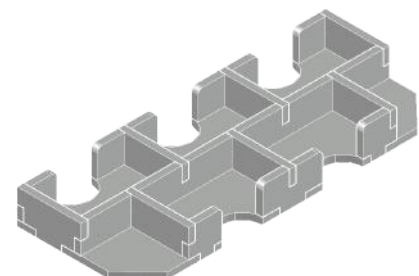
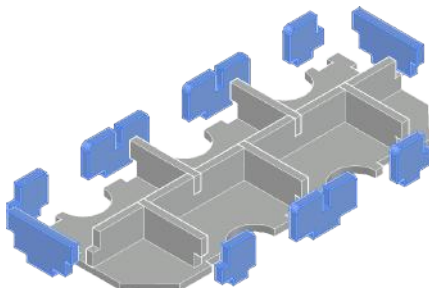
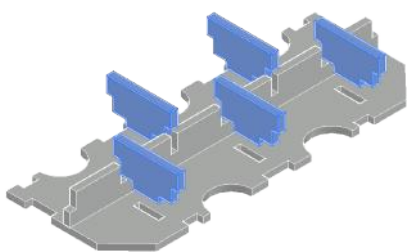
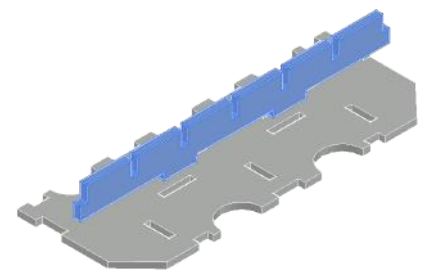
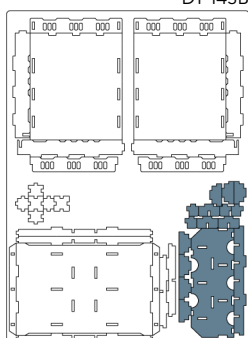

G

2x



DT-143B

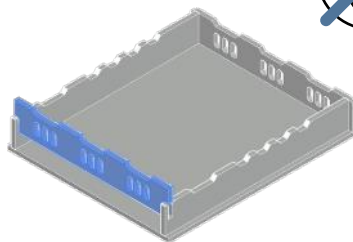
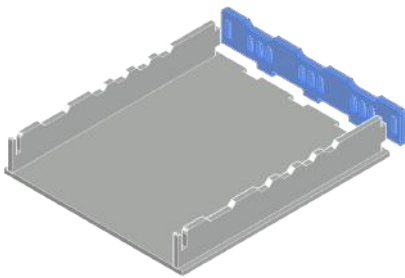
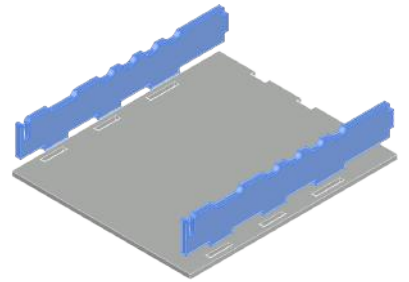
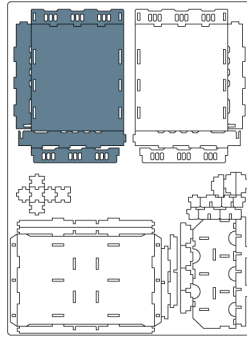

**NOTE:** Don't use glue on this joint; this piece can be removed during the game. Non usare colla su questo incastro, pezzo rimovibile durante il gioco.

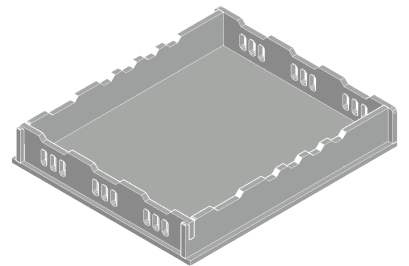

DT-143B

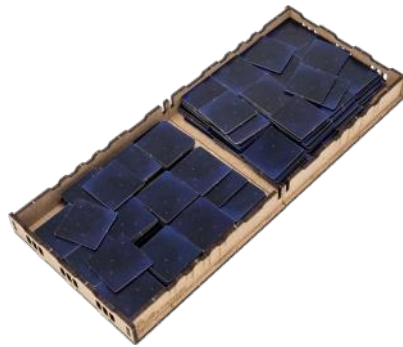
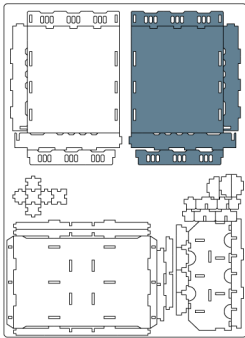

If you like you can bring the two trays closer together and use them for drawing spaceship components. Se ti piace puoi avvicinare i due vassoi tra loro ed utilizzarli per la pesca dei componenti delle astronavi.

## REBOXING SEQUENCE!



Designed to fit into the game box. Once inserted all the components from base and expansion, lid will sit by 1cm approximately. To have a flush closure store expansion boards elsewhere. Progettato per inserirsi all'interno della scatola di gioco. Inserendo tutti i componenti di gioco base ed esp la scatola alzerà di 1cm circa. Per una chiusura a filo riporre altrove le mappe dell'espansione.



Every piece will stay in its slot. Follow the reboxing sequence to properly store your organizer. We recommend using a h-band to avoid accidental box opening. Don't shake. Ogni componente rimarrà al suo posto. Segui la sequenza di reinserimento per riporre nella maniera corretta il tuo organizer. Consigliamo l'utilizzo di una h-band per evitare aperture accidentali. Non scuotere.



Non-recyclable waste.  
Smaltire i materiali di scarto nell'indifferenziata.

All trademarks and copyrights are the property of their respective owners.  
This product is not a toy. Contains small parts that can be swallowed or inhaled. 14+