

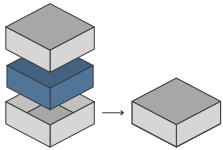

ORGANIZER - COMPATIBLE WITH CARNEGIE



Designed to fit into the game box; flush closure is guaranteed. Progettato per inserirsi all'interno della scatola del gioco; garantisce chiusura a filo*



Designed for both sleeved and unsleeved cards. Adatto sia per carte imbustate che non imbustate*

30.5 x 21.6 x 7.4 cm

Size of assembled organiser
Dimensioni organizer assemblato

ORGANIZER CAPACITY

4x player set boxes; 1x department tray, with slots for each type; 1x department storage box; 1x card holder; 1x box for setup meeples and tokens; 2x resource holders, with dedicated slots; 1x timeline tiles tray. 4x scatole set giocatore; 1x plancia dipartimenti, con slot per ogni tipologia; 1x scatola storage dipartimenti; 1x portacarte; 1x scatola per meeples e token setup; 2x portarisorsa, con slot dedicati; 1x contenitore per timeline tiles.



* Any doubt? Check out our FAQ page or download the digital version of the instructions on our website!

All trademarks and copyrights are the property of their respective owners.
This product is not a toy. Contains small parts that can be swallowed or inhaled. 14+





ORGANIZER - COMPATIBLE WITH CARNEGIE

TUTORIAL - THE DICETROYERS DICE!

Among the pieces to assemble, you'll find a dice. This is not part of the organizer, but it can be a good starting point to practice!

Tra i materiali da assemblare troverai un dado. Questo componente non fa parte dell'organizer, né del gioco, ma è un ottimo punto di partenza per fare un po' di pratica.

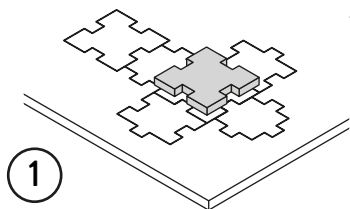

1

Gently take off
all the pieces.
Stacca delicatamente
dal foglio tutti i pezzi.

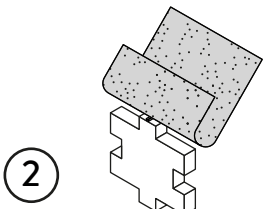

2

If necessary, use sand paper to
smoothen the borders.
Se necessario rifila con carta
vetrata per legno eventuali
imperfezioni dei pezzi.

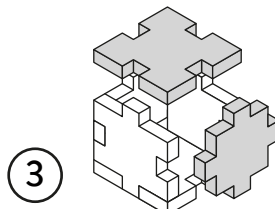

3

Get familiar with
all the pieces
and check the correct assembly
sequence.
Prendi familiarità con tutti
i pezzi, per assicurarti
che la sequenza di assemblaggio sia
corretta.

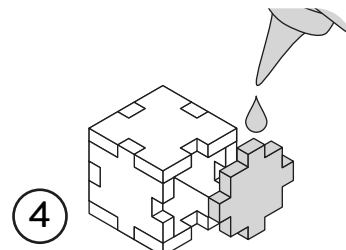

4

Once verified the correct assembly
sequence, just add a small quantity
of PVA glue on every joint.
Dopo aver verificato
la sequenza di assemblaggio
aggiungi una piccola quantità di
colla vinilica su tutti
gli incastri per garantirne
la durata nel tempo.

INSTRUCTIONS

A



DT-154A

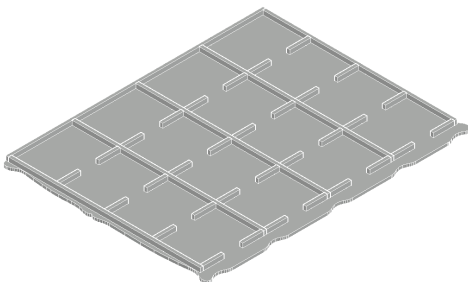
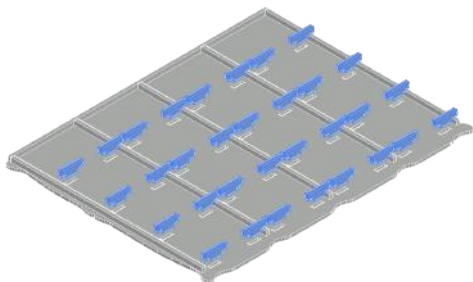
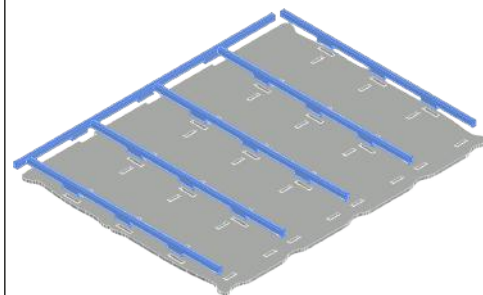
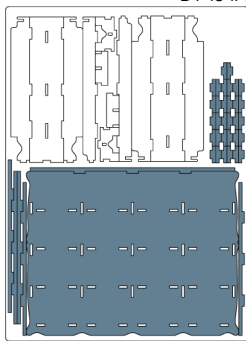

B

4x



DT-154A

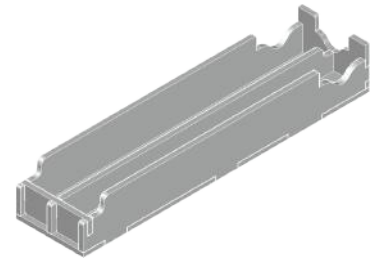
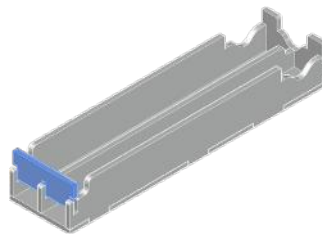
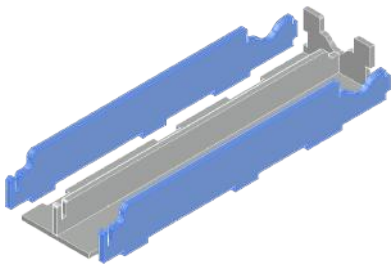
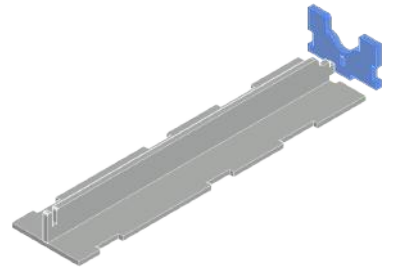
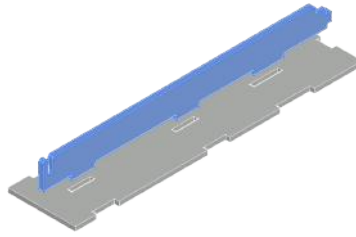
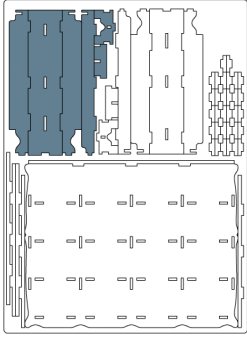

NOTE: Don't use glue on this joint; this piece can be removed during the game. Non usare colla su questo incastro, pezzo rimovibile durante il gioco.

DT-154A

DT-154B

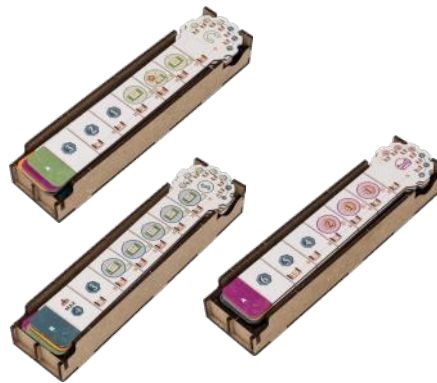
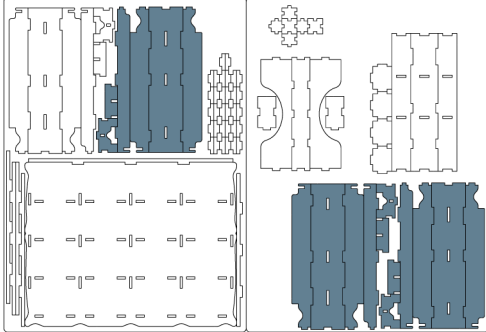

C



DT-154B

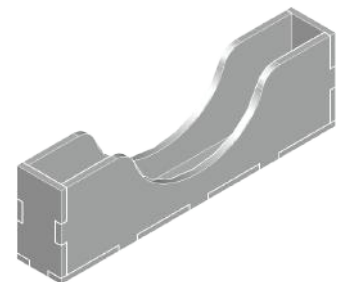
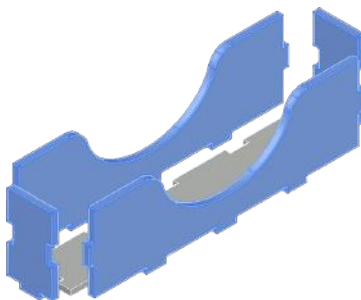
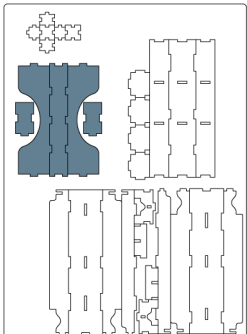

D



NOTE: The \$10 tokens go into the largest slot.
I token da 10\$ vanno nello slot più grande.

DT-154B

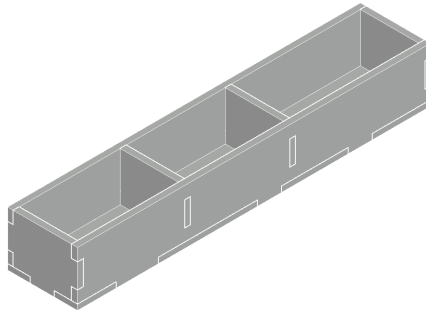
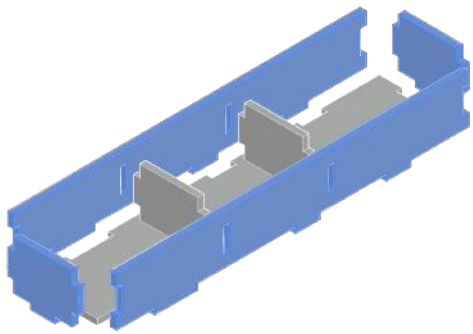
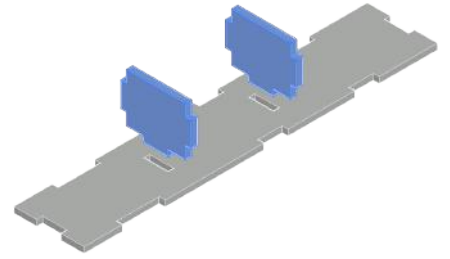
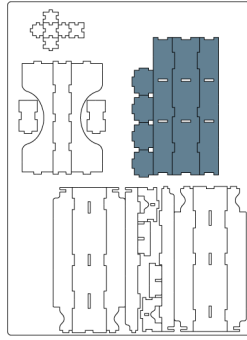

E



DT-154C

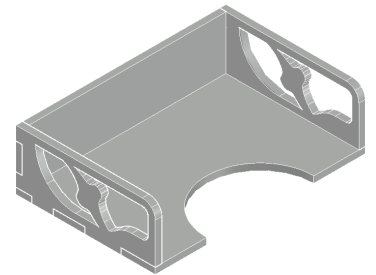
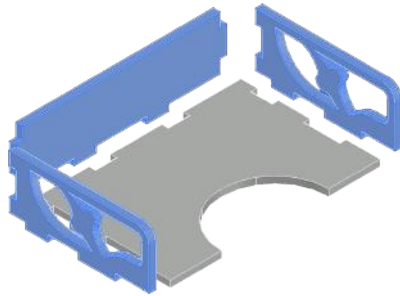
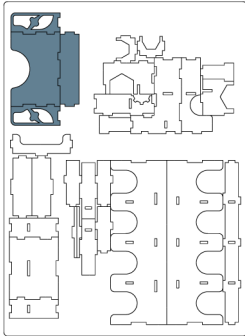

F



DT-154C

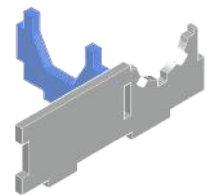
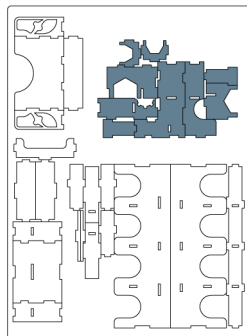

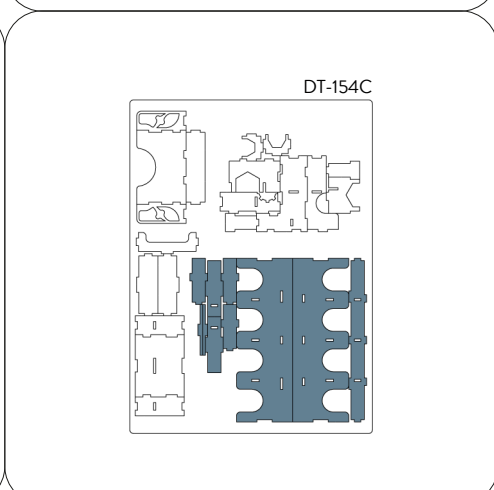
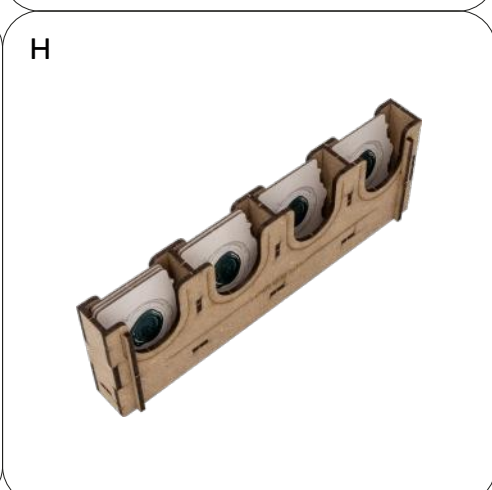
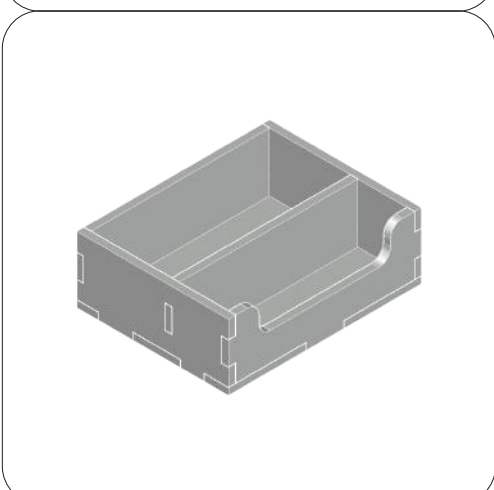
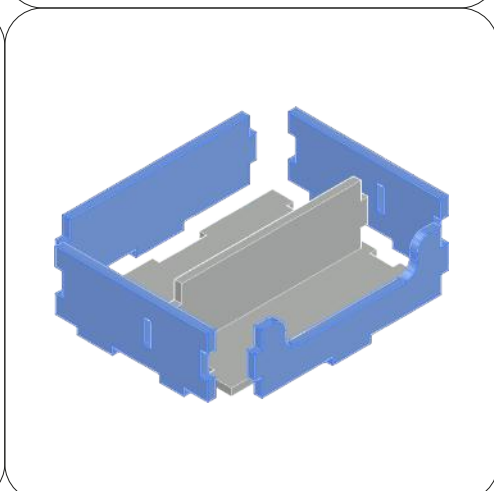
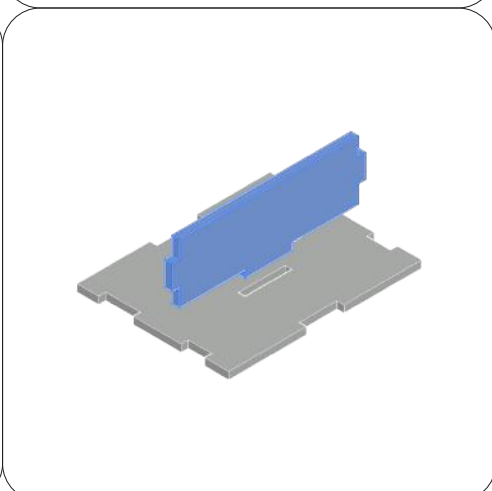
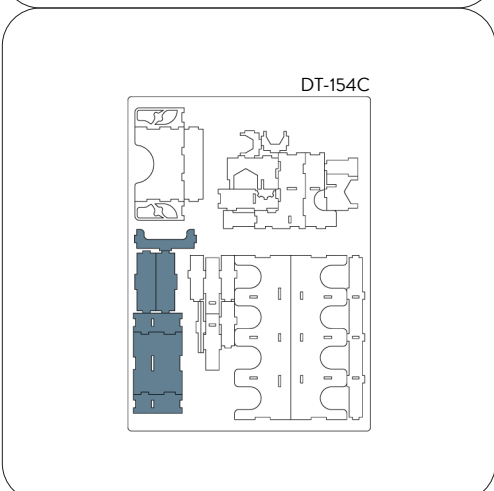
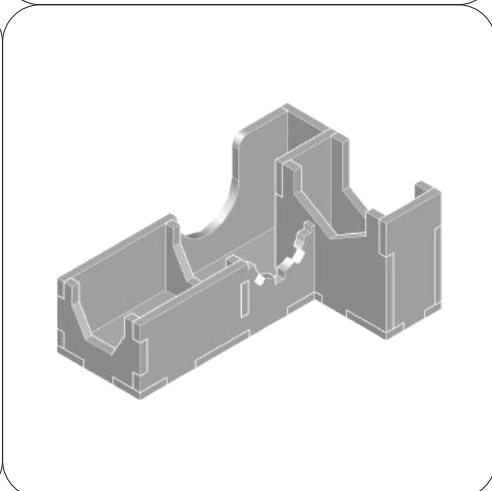
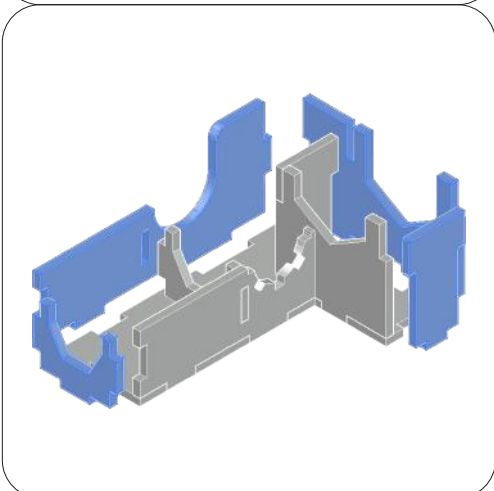
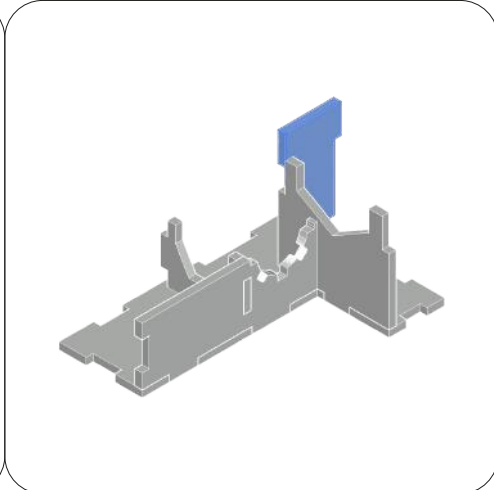
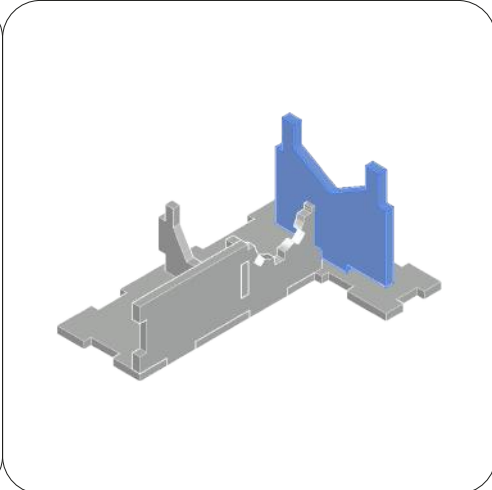
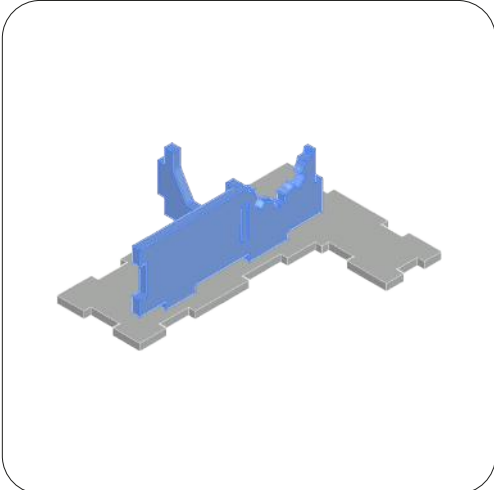

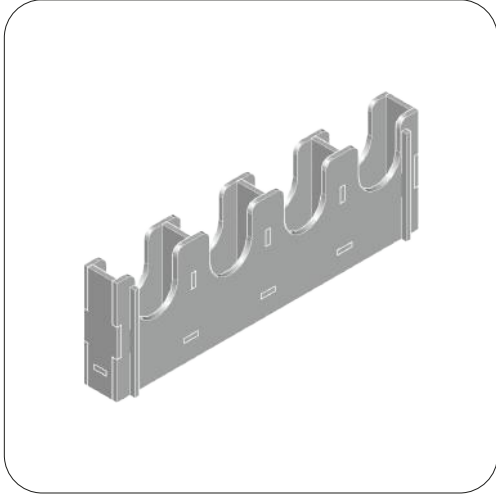
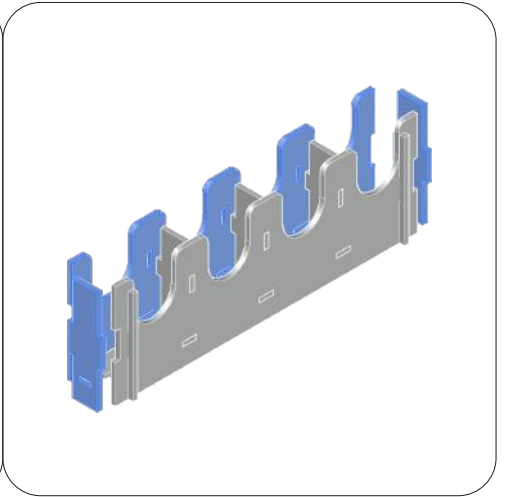
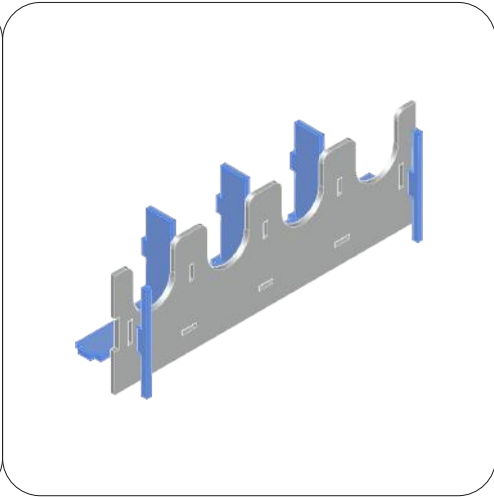
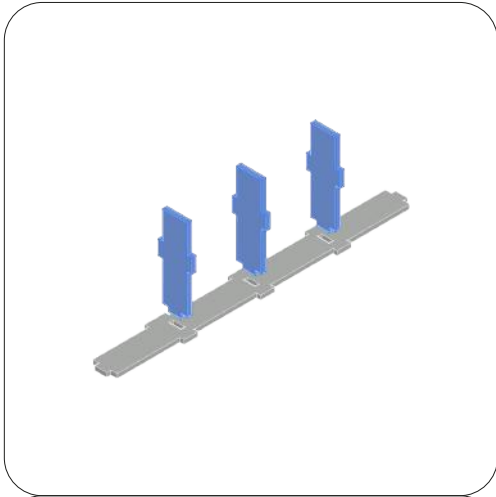

NOTE: Place Start and End tiles here.
Posiziona qui le tiles Inizio e Fine.

REBOXING SEQUENCE!



Every piece will stay in its slot. Follow the reboxing sequence to properly store your organizer. We recommend using a h-band to avoid accidental box opening. Don't shake. Ogni componente rimarrà al suo posto. Segui la sequenza di reinserimento per riporre nella maniera corretta il tuo organizer. Consigliamo l'utilizzo di una h-band per evitare aperture accidentali. Non scuotere.



All trademarks and copyrights are the property of their respective owners.
This product is not a toy. Contains small parts that can be swallowed or inhaled. 14+