

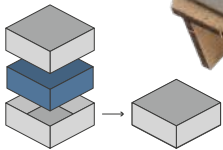

ORGANIZER - COMPATIBLE WITH THE WOLVES



Designed to fit into the game box; flush closure is guaranteed. Progettato per inserirsi all'interno della scatola del gioco; garantisce chiusura a filo*

Designed for both sleeved and unsleeved cards. Adatto sia per carte imbustate che non imbustate*

28.1 x 28.1 x 5.4 cm

Size of assembled organiser
Dimensioni organizer assemblato

ORGANIZER CAPACITY

5x player set boxes with slots for each piece type; 1x resource holder for VP, bonus terrain and action tokens; 1x setup tray with dedicated slots; 1x tray for map tiles and help cards; 1x backbone for flush closure. 5x scatoline con set giocatore. Slot divisi per tipologia pezzi; 1x portarisorse per PV, azione e terreno bonus; 1x tray setup con slot dedicati; 1x contenitore per tile mappa e carte guida; 1x struttura portante per chiusura a filo.



* Any doubt? Check out our FAQ page or download the digital version of the instructions on our website!

All trademarks and copyrights are the property of their respective owners. This product is not a toy. Contains small parts that can be swallowed or inhaled. 14+





ORGANIZER - COMPATIBLE WITH THE WOLVES



TUTORIAL - THE DICETROYERS DICE!

Among the pieces to assemble, you'll find a dice. This is not part of the organizer, but it can be a good starting point to practice!

Tra i materiali da assemblare troverai un dado. Questo componente non fa parte dell'organizer, né del gioco, ma è un ottimo punto di partenza per fare un po' di pratica.

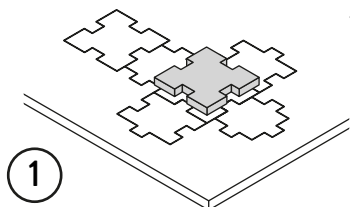

1

Gently take off
all the pieces.
Stacca delicatamente
dal foglio tutti i pezzi.

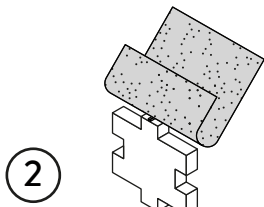

2

If necessary, use sand paper to
smoothen the borders.
Se necessario rifila con carta
vetrata per legno eventuali
imperfezioni dei pezzi.

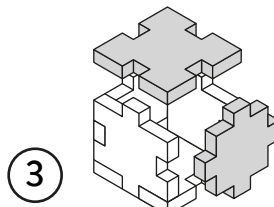

3

Get familiar with
all the pieces
and check the correct assembly
sequence.
Prendi familiarità con tutti
i pezzi, per assicurarti
che la sequenza di assemblaggio sia
corretta.

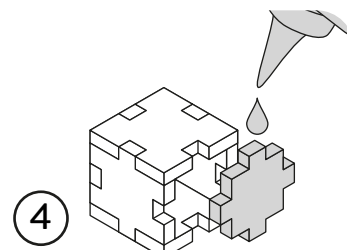

4

Once verified the correct assembly
sequence, just add a small quantity
of PVA glue on every joint.
Dopo aver verificato
la sequenza di assemblaggio
aggiungi una piccola quantità di
colla vinilica su tutti
gli incastri per garantirne
la durata nel tempo.

INSTRUCTIONS

A



DT-139A

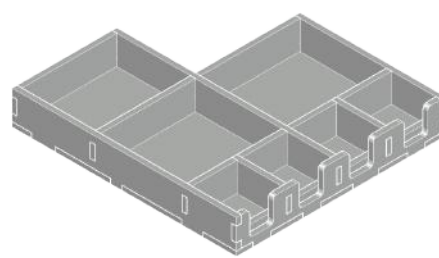
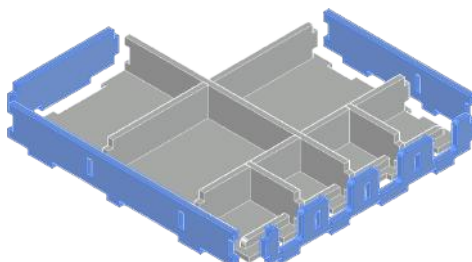
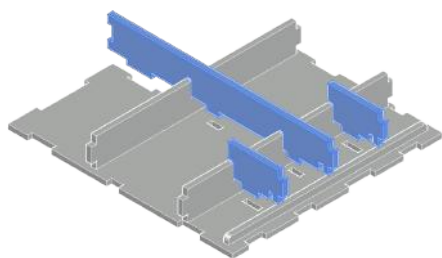
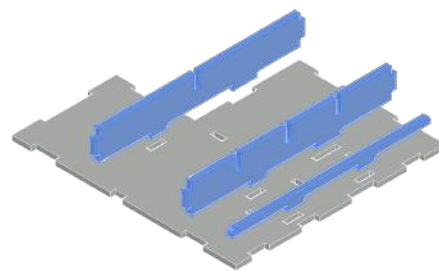
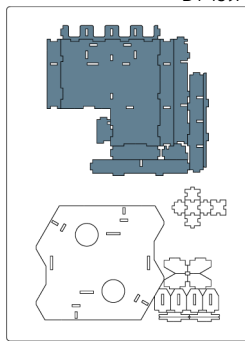

B

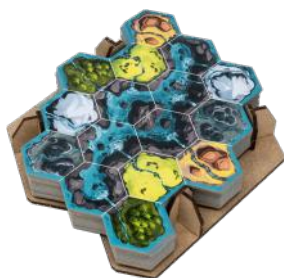

DT-139A

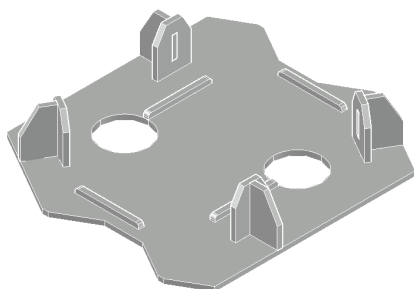
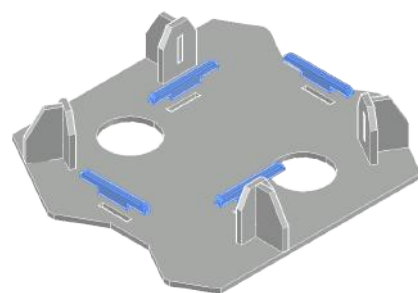
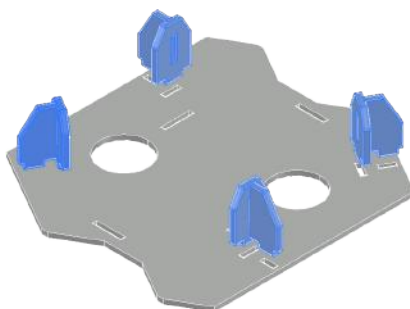
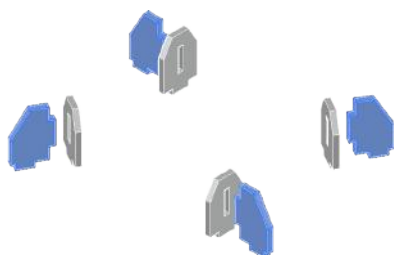
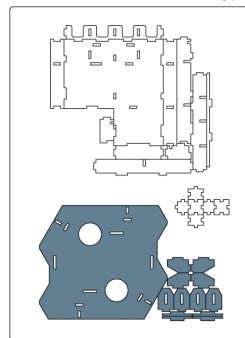

C



DT-139B

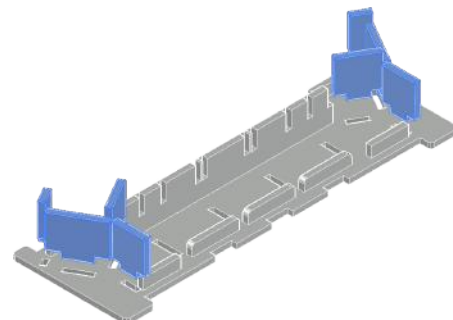
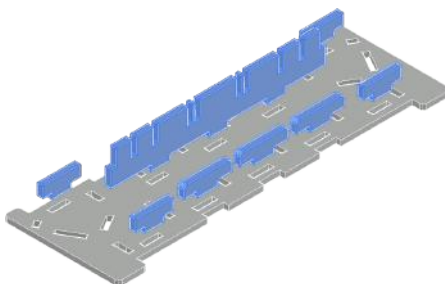
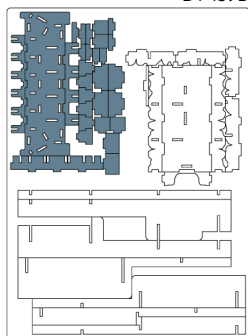

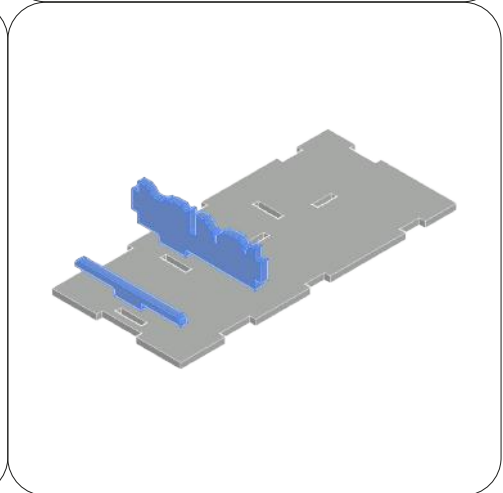
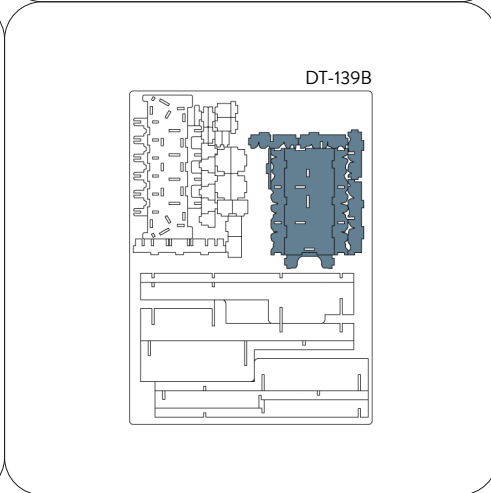
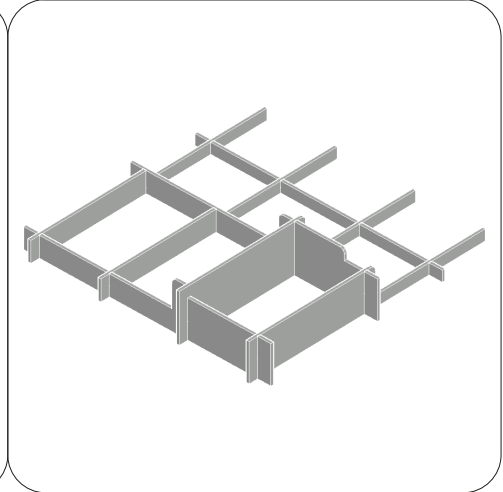
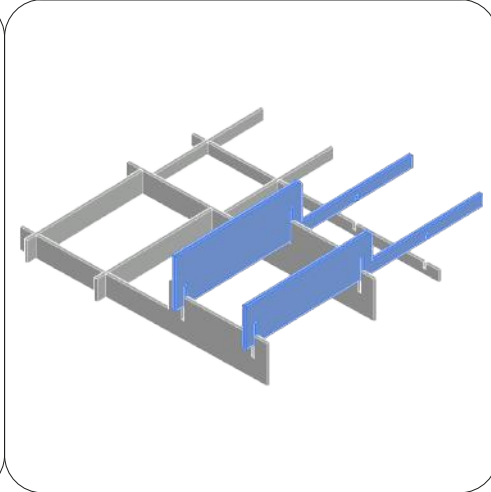
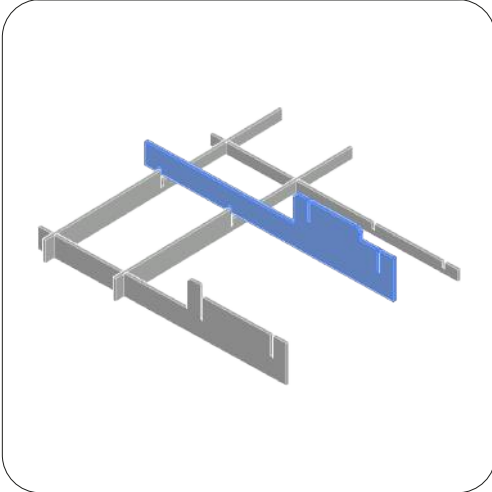
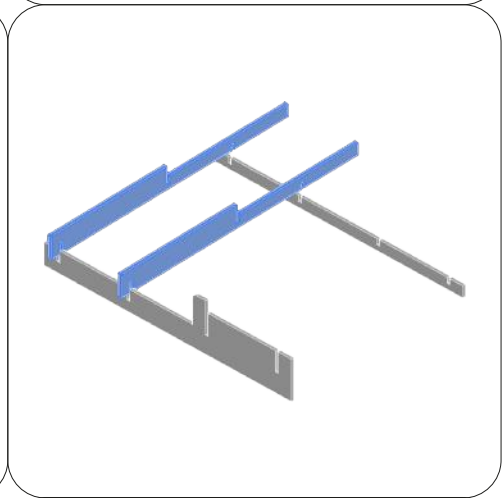
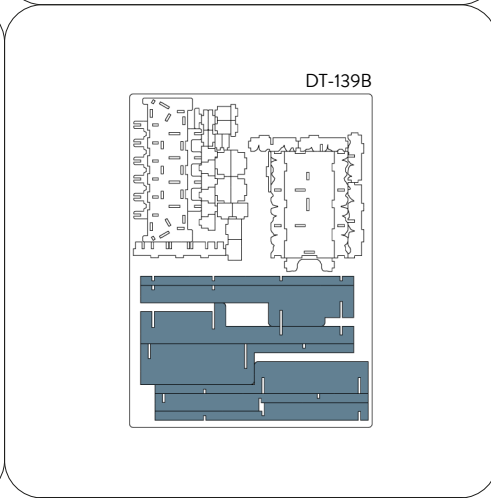
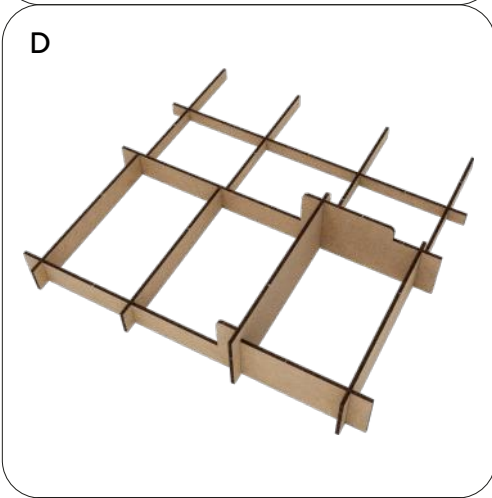
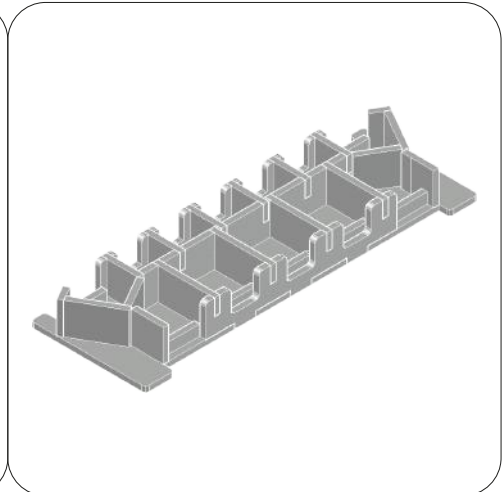
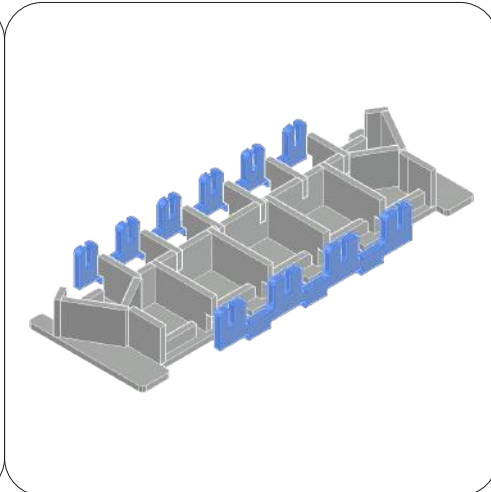
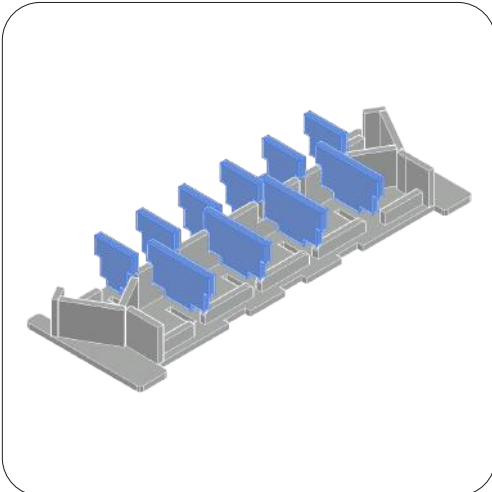

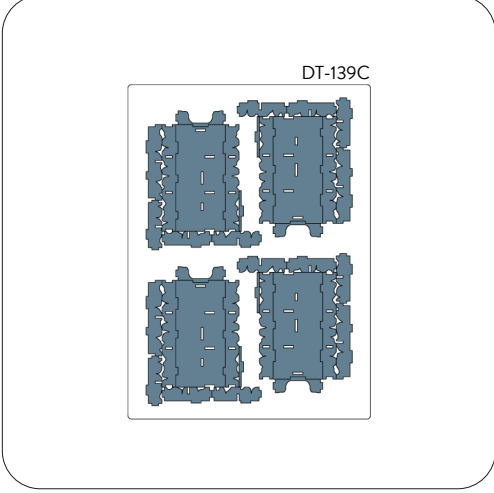
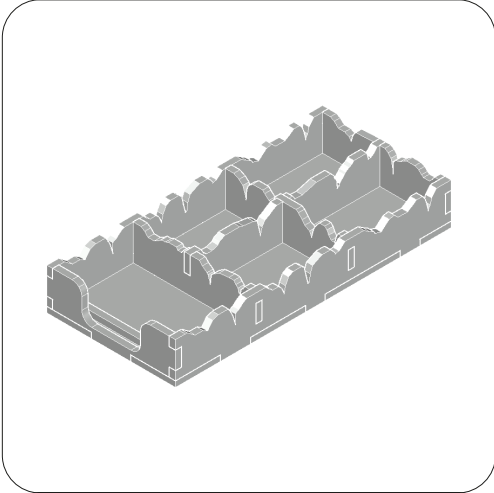
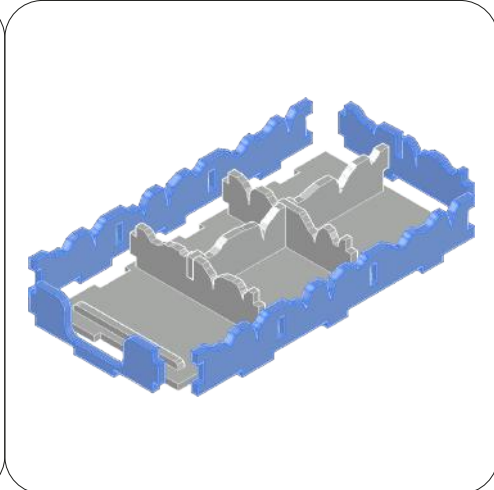
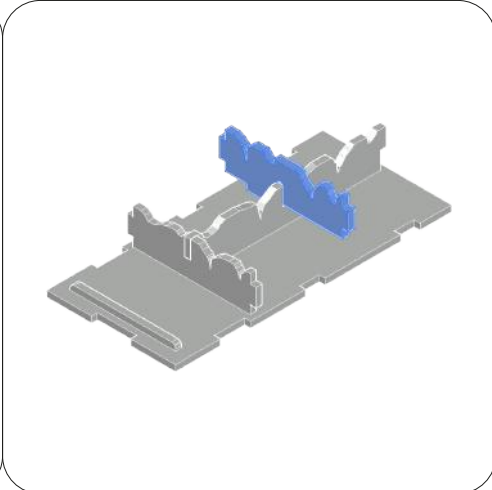
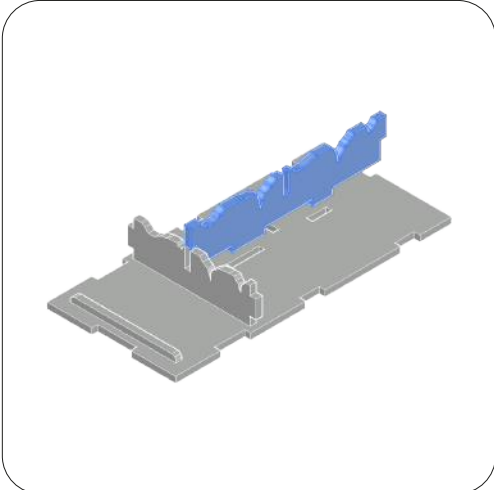

REBOXING SEQUENCE!



**VERTICAL
STORAGE
SAFETY**



Every piece will stay in its slot. Follow the reboxing sequence to properly store your organizer. We recommend using a h-band to avoid accidental box opening. Don't shake. Ogni componente rimarrà al suo posto. Segui la sequenza di reinserimento per riporre nella maniera corretta il tuo organizer. Consigliamo l'utilizzo di una h-band per evitare aperture accidentali. Non scuotere.



Non-recyclable waste.
Smaltire i materiali di
scarto nell'indifferenziata.

All trademarks and copyrights are the property of their respective owners.
This product is not a toy. Contains small parts that can be swallowed or inhaled. 14+