

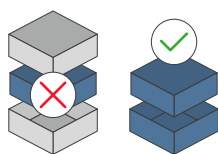

STORAGE SYSTEM - COMPATIBLE WITH ARKHAM HORROR LCG



Designed to be an independent card holder Progettato per essere un box portacarte indipendente dalla scatola di gioco



Designed for both sleeved and unsleeved cards. Adatto sia per carte imbustate che non imbustate*

73



Pieces to assemble
Pezzi da assemblare

25.1 x 32.9 x 8.6 cm



Size of assembled organiser
Dimensioni organizer assemblato

ORGANIZER CAPACITY

6 rotating card holder + 4 lateral slots. Box Capacity: unsleeved cards 1667 cards; 40 micron sleeves (eg Mayday) 1400 cards; 60 micron sleeves (eg. Sapphire) 1250 cards; 100 micron sleeves (eg. Dragon Shield) 1000 cards. (The capacity is approximated and may vary depending on the thickness tolerance of used sleeves. The actual results may be different from the above); Lid with open/close rotating seal; 6 removable dividers. 6 spazi carte rotanti + 4 laterali. Capacità totale: non imbustate 1667 carte; buste 40micron (eg. Mayday) 1400 carte; buste 60micron (eg. Sapphire) 1250 carte; buste 100micron (eg. Dragon Shield) 1000 carte. (La capacità è approssimativa e può variare in funzione della tolleranza di spessore delle bustine utilizzate. Il risultato effettivo può risultare differente rispetto a quanto sopra riportato); Coperchio con sigillo di chiusura; 6 divisori rimovibili.



* Any doubt?
Check out our FAQ page or download the digital version of the instructions on our website!

All trademarks and copyrights are the property of their respective owners.
This product is not a toy. Contains small parts that can be swallowed or inhaled. 14+





STORAGE SYSTEM- COMPATIBLE WITH ARKHAM HORROR LCG



TUTORIAL - THE DICETROYERS DICE!

Among the pieces to assemble, you'll find a dice. This is not part of the organizer, but it can be a good starting point to practice!

Tra i materiali da assemblare troverai un dado. Questo componente non fa parte dell'organizer, né del gioco, ma è un ottimo punto di partenza per fare un po' di pratica.

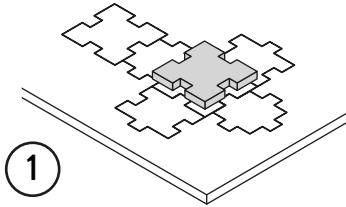

1

Gently take off
all the pieces.
Stacca delicatamente
dal foglio tutti i pezzi.

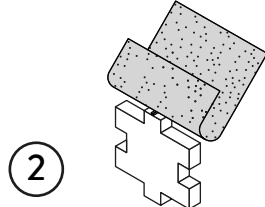

2

If necessary, use sand paper to
smoothen the borders.
Se necessario rifila con carta
vetrata per legno eventuali
imperfezioni dei pezzi.

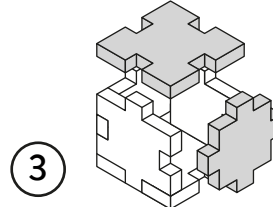

3

Get familiar with
all the pieces
and check the correct assembly
sequence.
Prendi familiarità con tutti
i pezzi, per assicurarti
che la sequenza di assemblaggio sia
corretta.

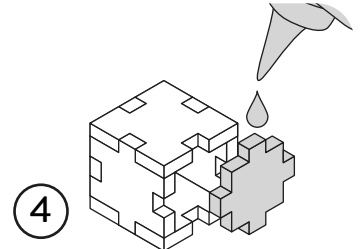

4

Once verified the correct assembly
sequence, just add a small quantity
of PVA glue on every joint.
Dopo aver verificato
la sequenza di assemblaggio
aggiungi una piccola quantità di
colla vinilica su tutti
gli incastri per garantirne
la durata nel tempo.

INSTRUCTIONS

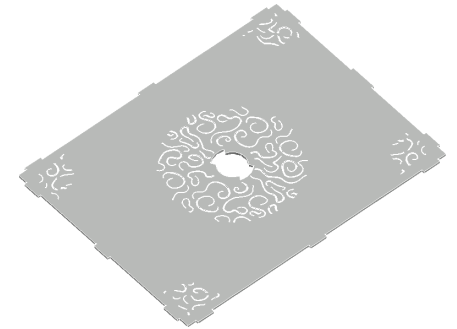
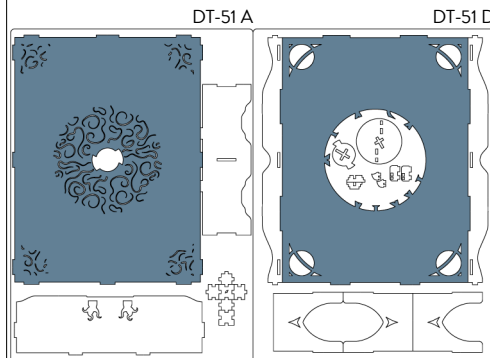

NOTE: Face the circle engraving upwards.
Rivolgì l'incisione del cerchio verso l'alto.

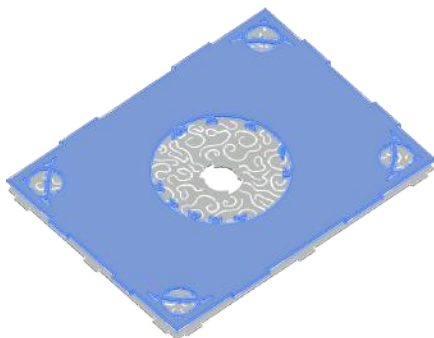

NOTE: Face the engravings upwards.
Rivolgì le incisioni verso l'alto

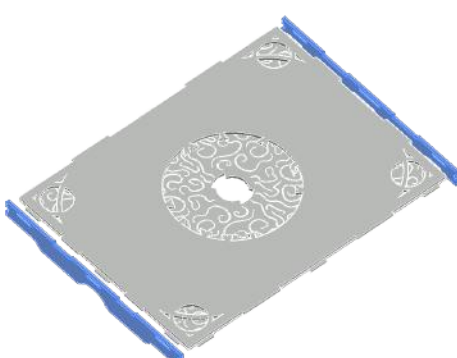
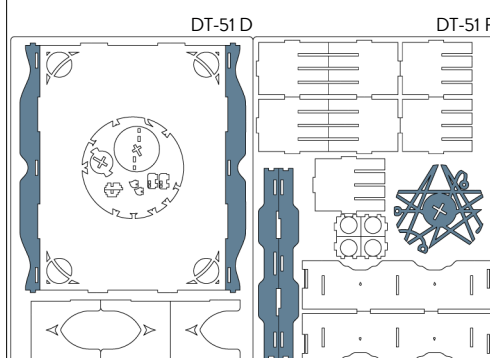



NOTE: Face the engravings upwards and make this piece match the drawing in the lid. Don't use glue on this joint; rotating element. Rivolgi le incisioni verso l'alto e fai in modo che questo pezzo corrisponda al disegno nel coperchio. Non usare colla su questo incastro, elemento rotante.

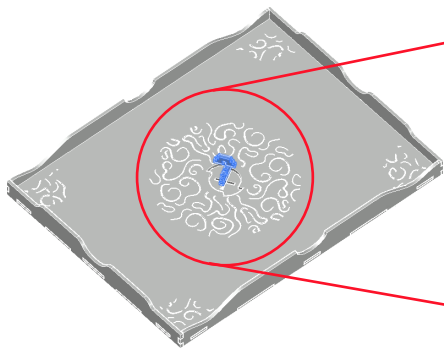
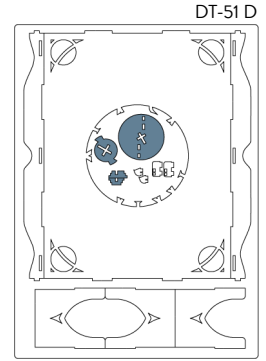
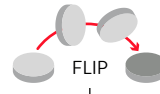

NOTE: Face the engravings upwards. Pay attention to glue only the joints; rotating element. Rivolgi le incisioni verso l'alto. Presta attenzione ad incollare solamente gli incastri; elemento rotante.



NOTE: Face the engravings upwards. Pay attention to glue only the joints; rotating element. Rivolgi le incisioni verso l'alto. Presta attenzione ad incollare solamente gli incastri; elemento rotante.



NOTE: Face the engravings upwards. Pay attention to glue only the joints; rotating element. Rivolgi le incisioni verso l'alto. Presta attenzione ad incollare solamente gli incastri; elemento rotante.

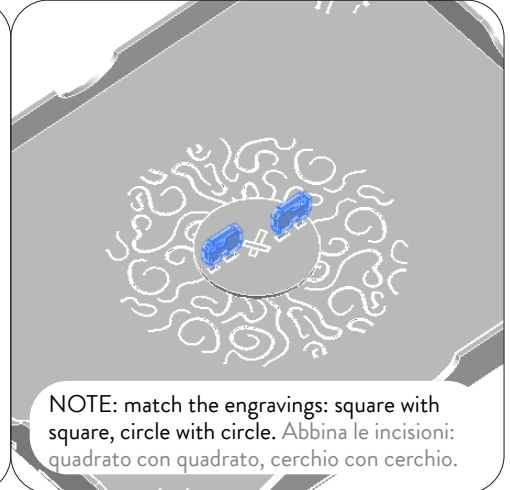
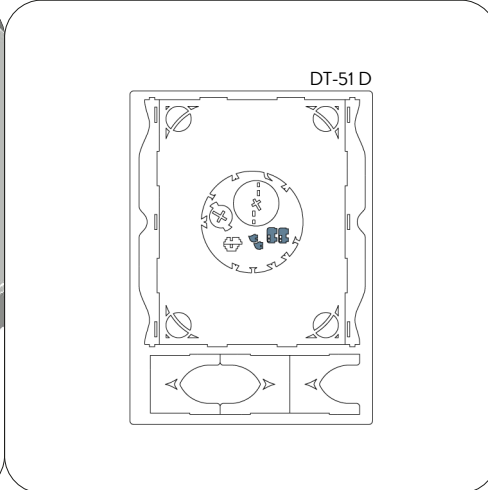

NOTE: match the engravings: square with square, circle with circle. Abbina le incisioni: quadrato con quadrato, cerchio con cerchio.

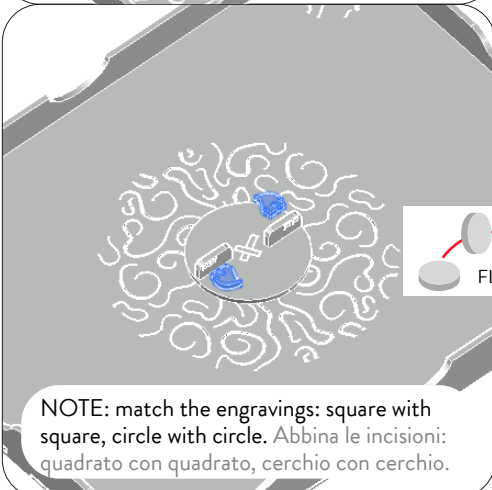

NOTE: match the engravings: square with square, circle with circle. Abbina le incisioni: quadrato con quadrato, cerchio con cerchio.

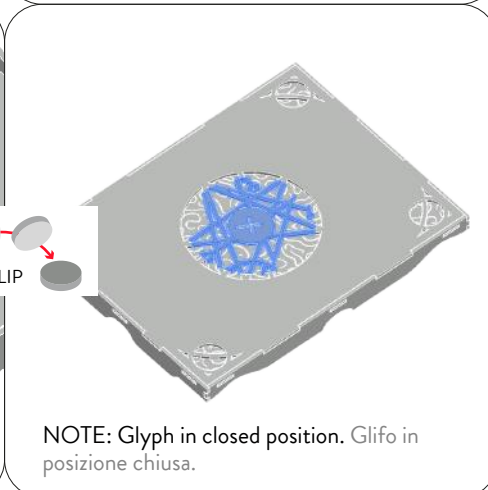
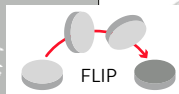

NOTE: Glyph in closed position. Glifo in posizione chiusa.



NOTE: Glyph in open position. Hold in open position before proceeding. Glifo in posizione aperta. Mantieni in posizione aperta prima di procedere.

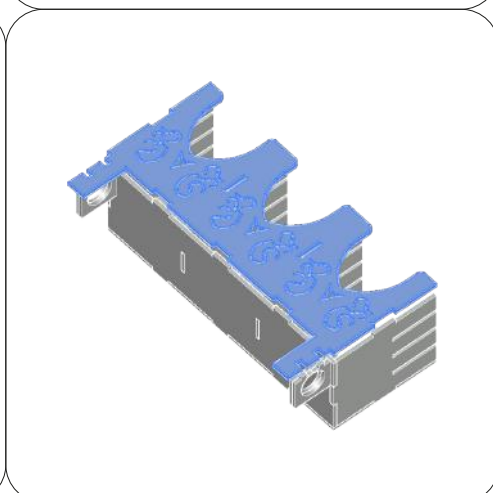
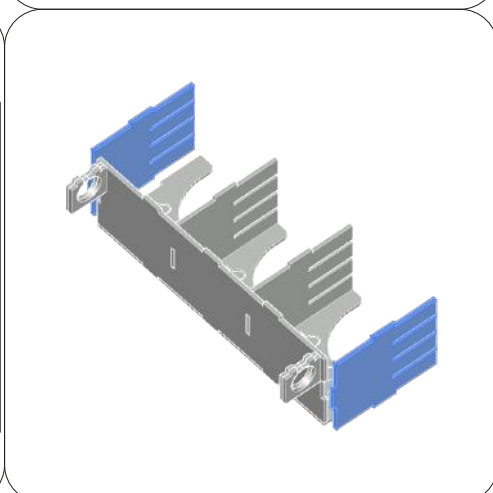
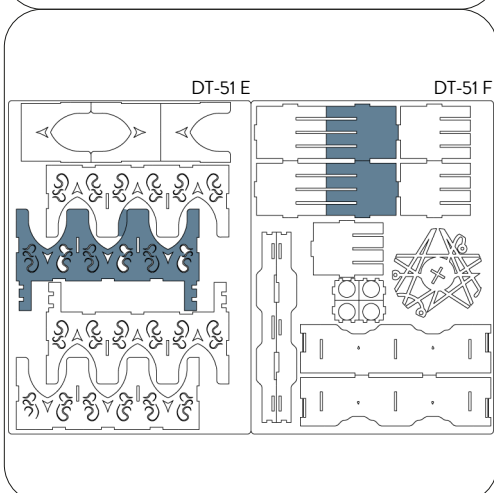
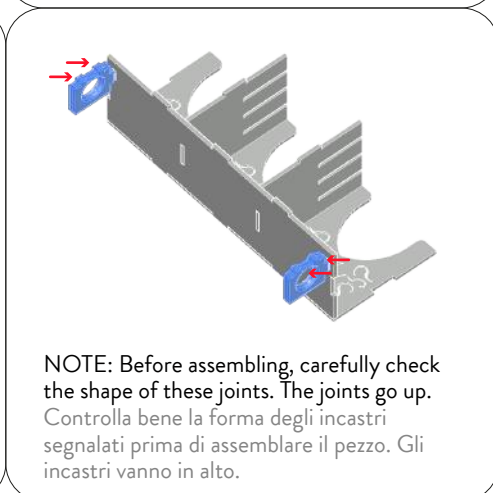
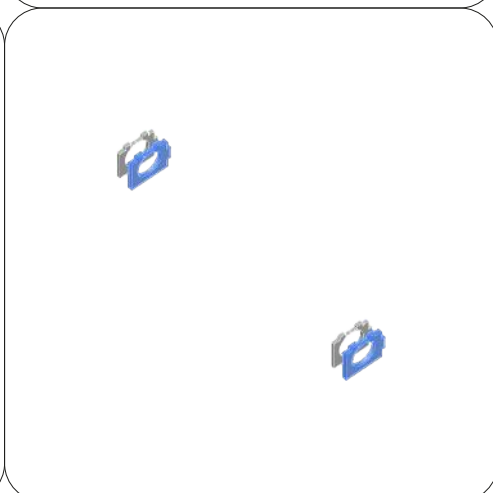
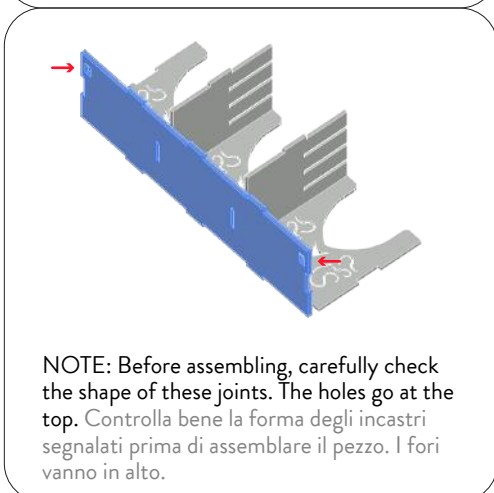
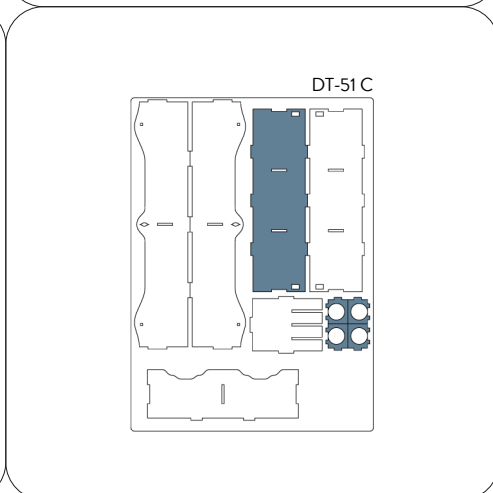
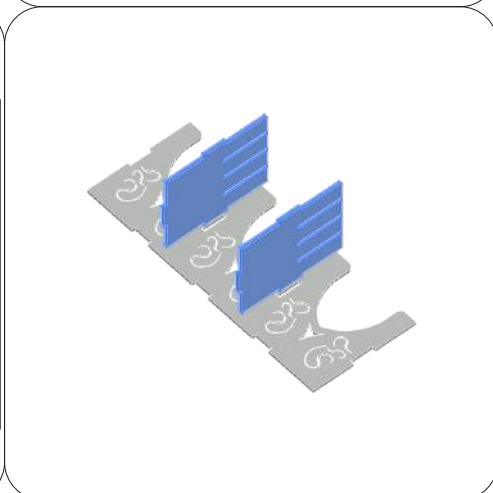
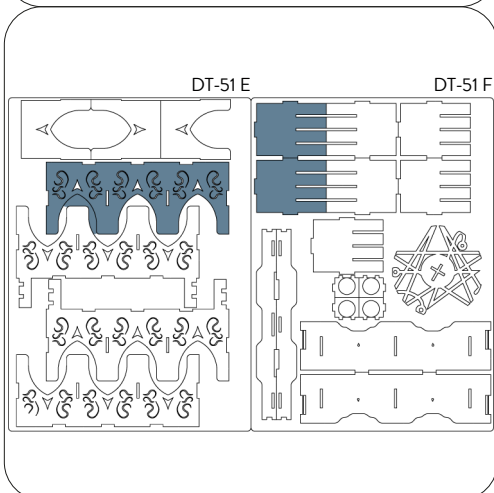

2x

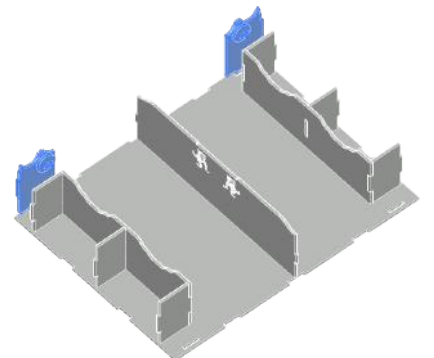
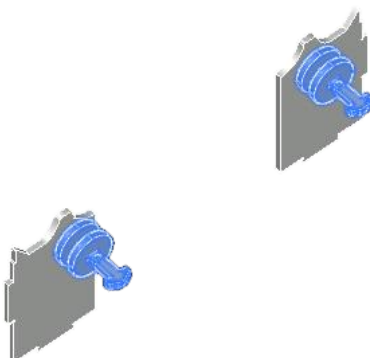
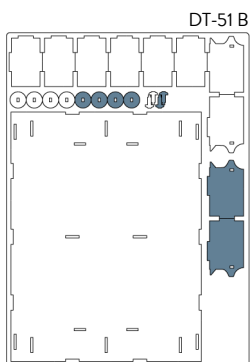
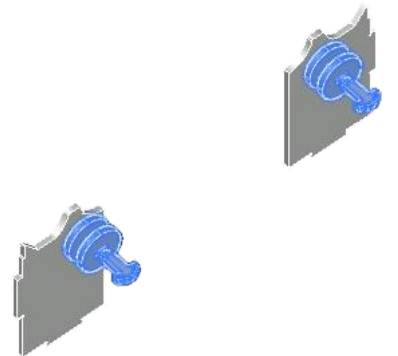
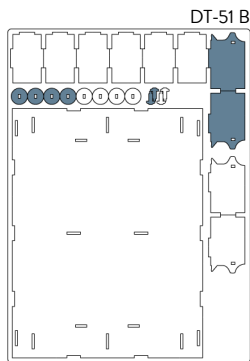
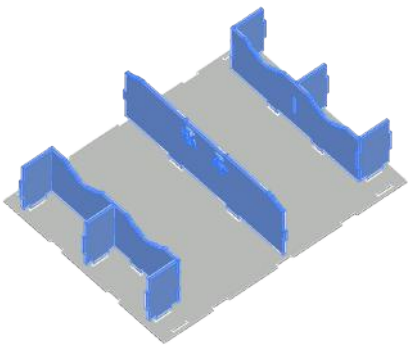
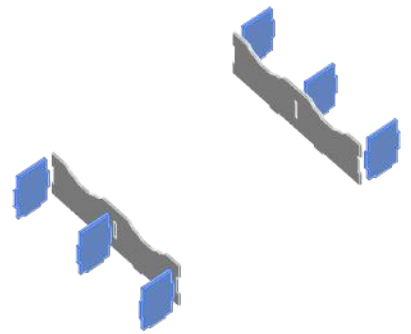
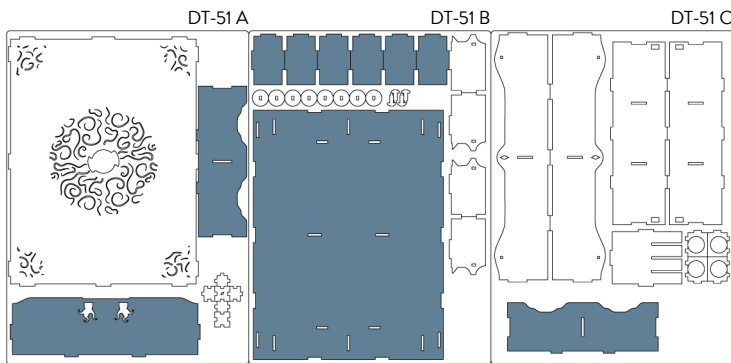
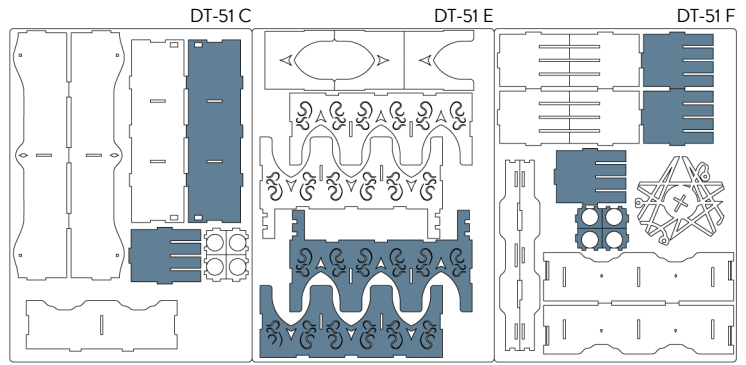
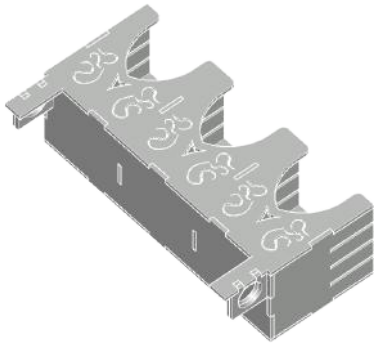

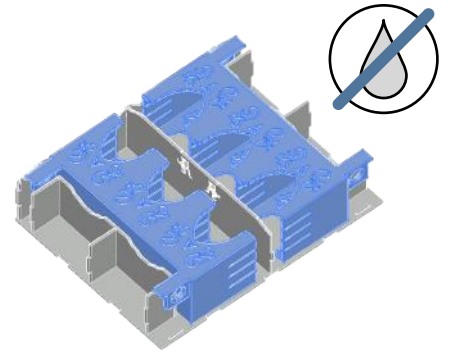
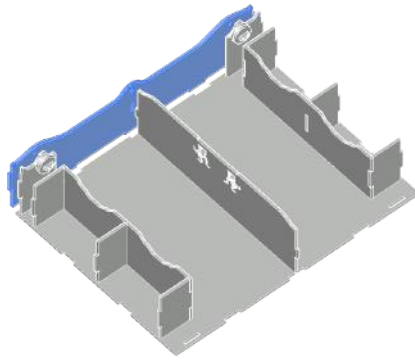
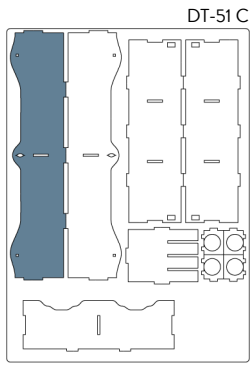

NOTE: Don't use glue on this joint; rotating element. Non usare colla su questo incastro, elemento rotante.

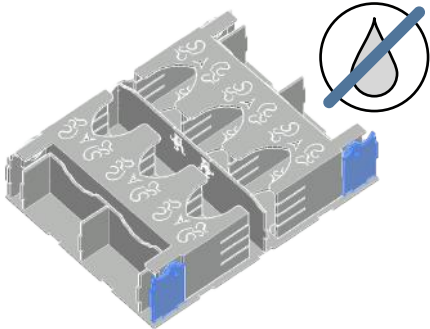

NOTE: Don't use glue on the rotating elements. Use glue only on the base. Non usare colla sui rotanti. Incollare solamente sulla base.

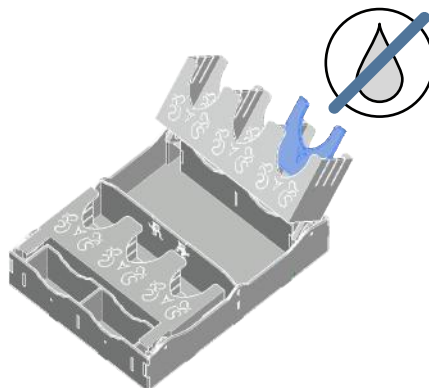
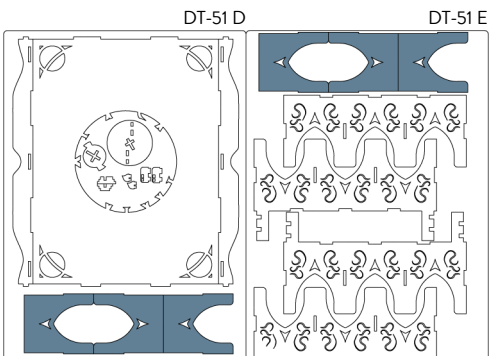
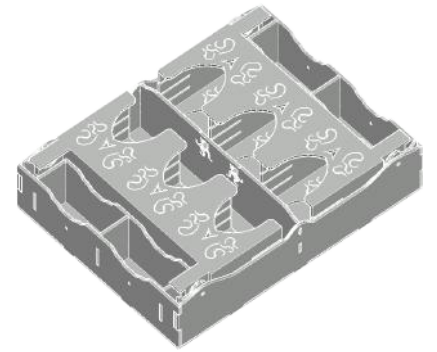
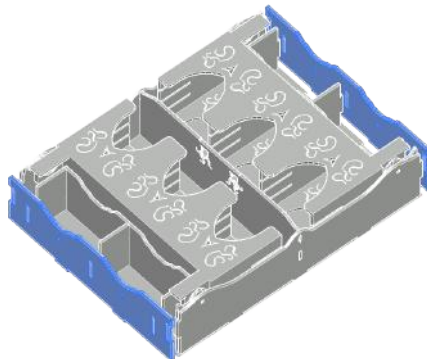
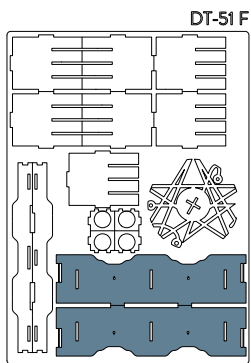
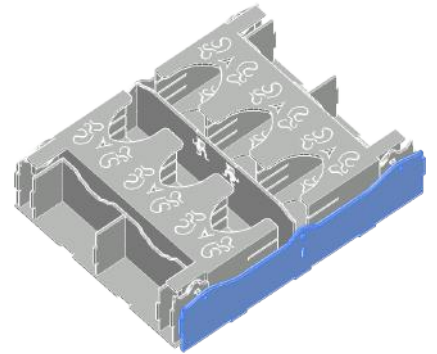
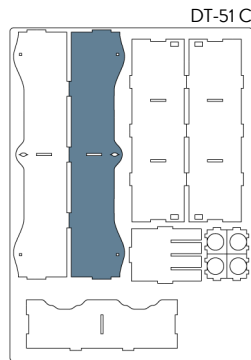

NOTE: Don't use glue on the movable dividers. Non usare colla sui divisori mobili.



GLYPH IN OPEN POSITION.
GLIFO IN POSIZIONE APERTA.



GLYPH IN CLOSED POSITION.
GLIFO IN POSIZIONE CHIUSA.



Take care, don't overturn the box!
Riporre con cura la scatola, non ribaltare!



Non-recyclable waste
Smaltire i materiali di scarto nell'indifferenziata

All trademarks and copyrights are the property of their respective owners.
This product is not a toy. Contains small parts that can be swallowed or inhaled. 14+