

THE PUZZLE

THE UNIVERSAL TRAY SYSTEM TO ORGANIZE AND PLAY YOUR FAVOURITE BOARD GAMES

SCRATCH

LONG

THIS TRAY SERIES IS DESIGNED TO FIT STANDARD SIZED CARDS

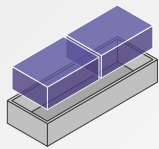

6.8 x 9.6 x 3 cm

Dimension of each slot

Dimensioni di ogni alloggiamento

Can fit several sizes, tested with 63.5x88mm; 57.5x89mm; 56x87mm sleeved and unsleeved cards.
Può ospitare diverse dimensioni, è stato testato con carte sia imbustate che non da 63,5x88mm; 57,5x89mm; 56x87mm*

MODULAR TRAY SYSTEM



SMALL

8 x 5.5 x 3.3 cm

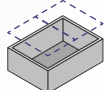

MEDIUM

8 x 11 x 3.3 cm

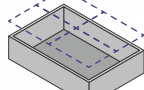

LARGE

16 x 11 x 3.3 cm

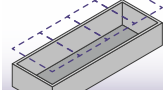

LONG

8 x 22 x 3.3 cm



The Puzzle is a modular system. The individual containers are multiples of each other in size.

You are purchasing a “long” container, which means that it will occupy the space of two medium containers, lengthwise.

The Puzzle è un sistema modulare. I singoli contenitori sono multipli in dimensioni uno rispetto all'altro.

Stai acquistando un contenitore “long”, il che significa che occuperà lo spazio di due contenitori medium, nel senso della lunghezza.



STACKABLE

Perfectly stackable thanks to our interlocking system.

Perfettamente impilabile grazie al nostro sistema ad incastro.

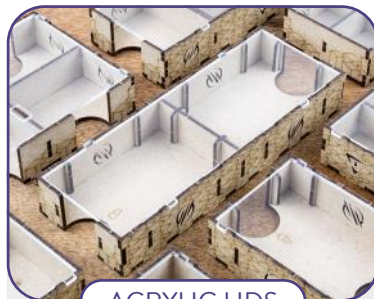

ACRYLIC LIDS

Acrylic lids available.

Find out them on our website.

Disponibili i coperchi in Plexiglass. Scopriteli sul nostro sito.

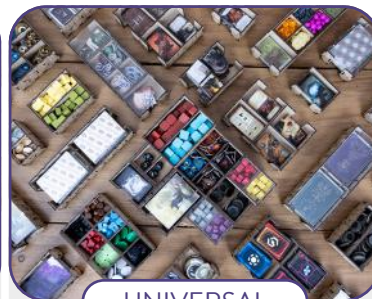

UNIVERSAL

Create your kit and use it for as many games as you want.

Crea il tuo kit e utilizzalo per tutti i giochi che vuoi.



BOX COMPATIBLE

You can also store them into the boxes of your games.

Puoi anche conservarli all'interno delle scatole dei tuoi giochi.

* Any doubt?
Check out our FAQ page or download the digital version of the instructions on our website!

All trademarks and copyrights are the property of their respective owners.
This product is not a toy. Contains small parts that can be swallowed or inhaled. 14+

THE PUZZLE'S
SCRATCH - LONG

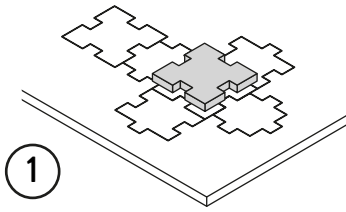
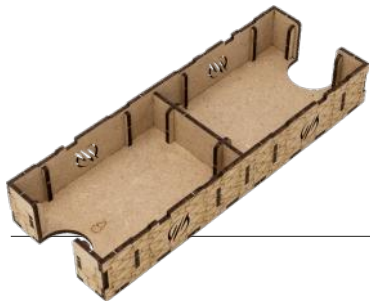

1

Gently take off
all the pieces.
Stacca delicatamente
dal foglio tutti i pezzi.

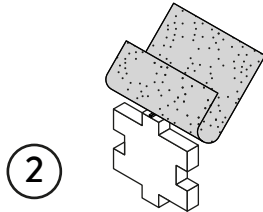

2

If necessary, use sand paper to
smoothen the borders.
Se necessario rifila con carta
vetrata per legno eventuali
imperfezioni dei pezzi.

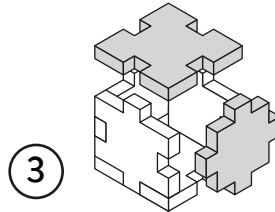

3

Get familiar with
all the pieces
and check the correct assembly
sequence.
Prendi familiarità con tutti
i pezzi, per assicurarti
che la sequenza di assemblaggio sia
corretta.

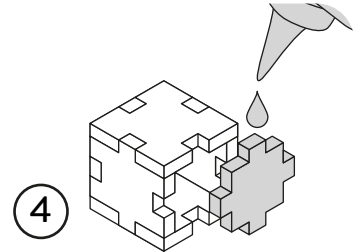

4

Once verified the correct assembly
sequence, just add a small quantity
of PVA glue on every joint.
Dopo aver verificato
la sequenza di assemblaggio
aggiungi una piccola quantità di
colla vinilica su tutti
gli incastri per garantirne
la durata nel tempo.

INSTRUCTIONS

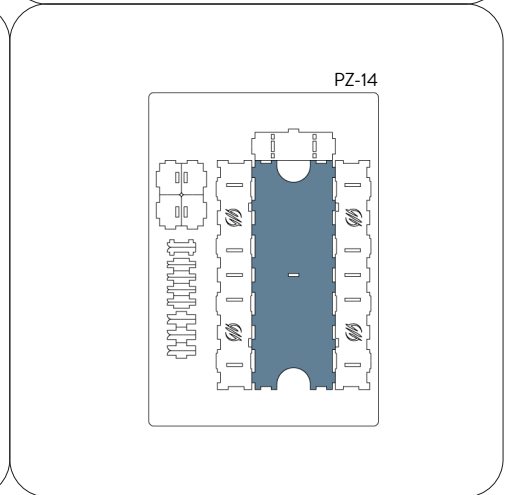
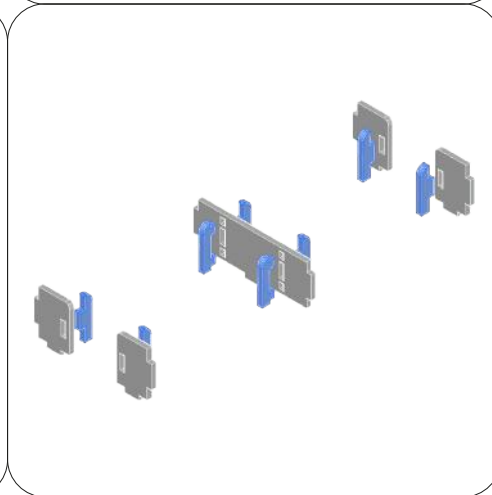
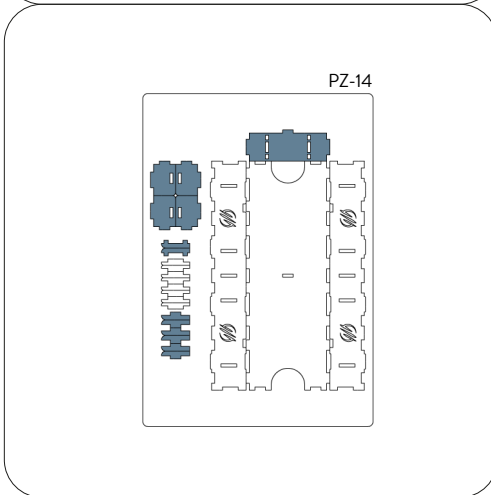
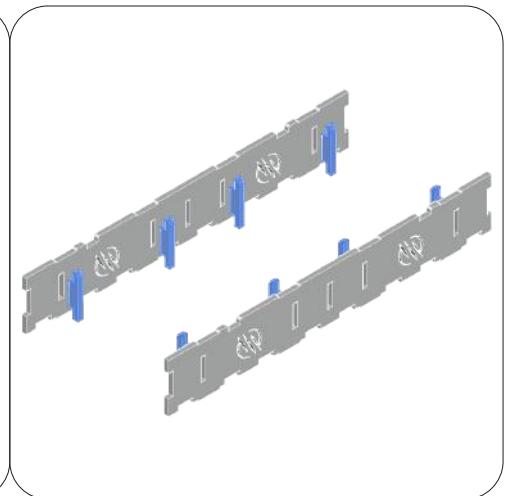
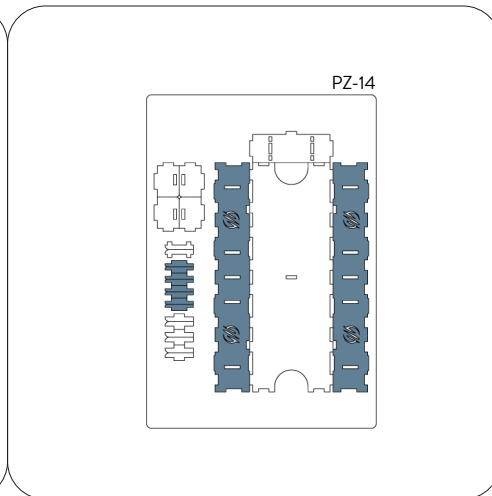
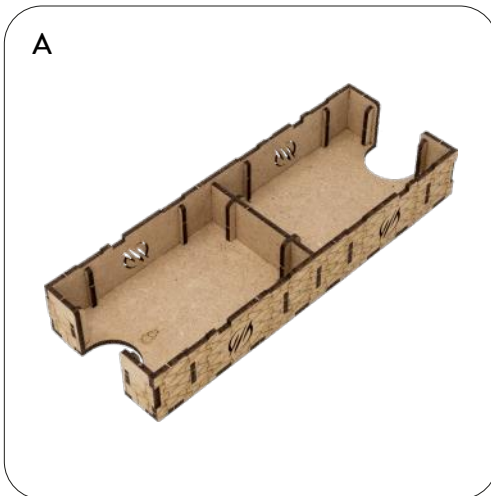

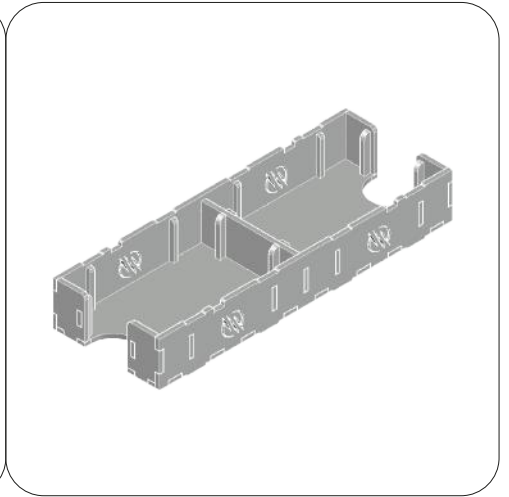
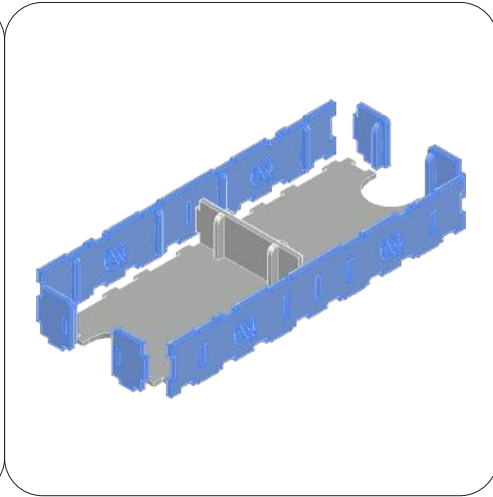
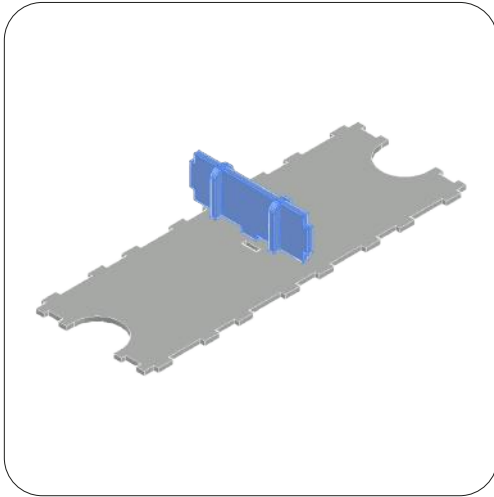

All trademarks and copyrights are the property of their respective owners.
This product is not a toy. Contains small parts that can be swallowed or inhaled. 14+



Non-recyclable waste. Smaltire i materiali di scarto nell'indifferenziata.