

THE PUZZLE

THE UNIVERSAL TRAY SYSTEM TO ORGANIZE AND PLAY YOUR FAVOURITE BOARD GAMES

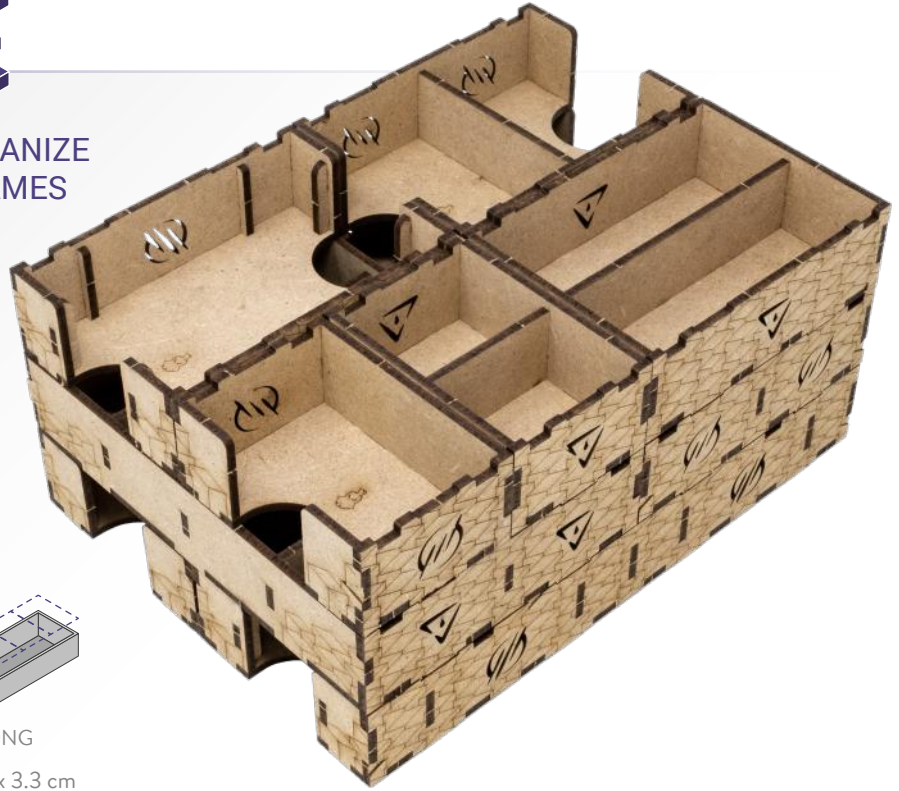

ESSENTIAL KIT

9 TRAYS, EACH WITH DIFFERENT SLOT SIZES, FOR THE WIDEST RANGE OF BOARD GAME COMPONENTS

MODULAR TRAY SYSTEM

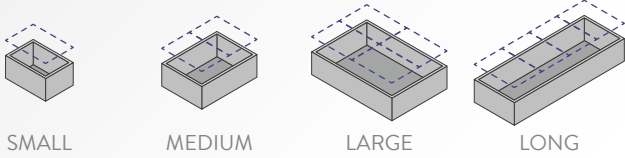

8 x 5.5 x 3.3 cm 8 x 11 x 3.3 cm 16 x 11 x 3.3 cm 8 x 22 x 3.3 cm

The Puzzle is a modular system. The individual containers are multiples of each other in size.
 The Puzzle è un sistema modulare. I singoli contenitori sono multipli in dimensioni uno rispetto all'altro.

WHAT IT CONTAINS

TRINITY SERIES



1x SMALL 1x MEDIUM 1x LARGE

ITCH SERIES



1x SMALL 1x MEDIUM 1x LARGE

ITCH & TRINITY



1x LONG

SCRATCH SERIES



1x MEDIUM 1x LONG



STACKABLE

Perfectly stackable thanks to our interlocking system.
 Perfettamente impilabile grazie al nostro sistema ad incastro.



ACRYLIC LIDS

Acrylic lids available. Find out them on our website.
 Disponibili i coperchi in Plexiglass. Scopriteli sul nostro sito.



UNIVERSAL

Create your kit and use it for as many games as you want.
 Crea il tuo kit e utilizzalo per tutti i giochi che vuoi.



BOX COMPATIBLE

You can also store them into the boxes of your games.
 Puoi anche conservarli all'interno delle scatole dei tuoi giochi.

* Any doubt?
 Check out our FAQ page or download the digital version of the instructions on our website!

All trademarks and copyrights are the property of their respective owners.
 This product is not a toy. Contains small parts that can be swallowed or inhaled. 14+



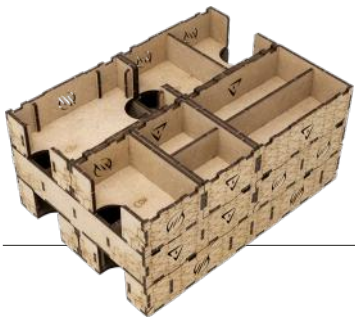

THE PUZZLE'S ESSENTIAL KIT

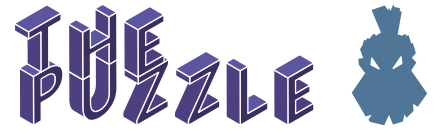

TUTORIAL - THE DICETROYERS DICE!

Among the pieces to assemble, you'll find a dice. This is not part of the organizer, but it can be a good starting point to practice!

Tra i materiali da assemblare troverai un dado. Questo componente non fa parte dell'organizer, né del gioco, ma è un ottimo punto di partenza per fare un po' di pratica.

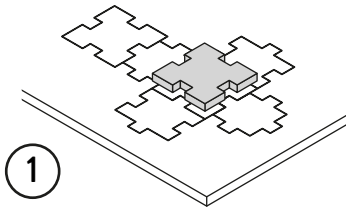

1

Gently take off all the pieces.
Stacca delicatamente dal foglio tutti i pezzi.

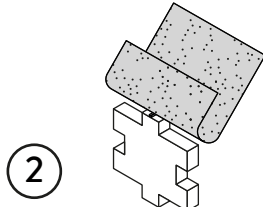

2

If necessary, use sand paper to smoothen the borders.
Se necessario rifila con carta vetrata per legno eventuali imperfezioni dei pezzi.

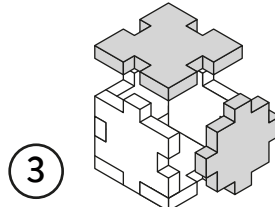

3

Get familiar with all the pieces and check the correct assembly sequence.
Prendi familiarità con tutti i pezzi, per assicurarti che la sequenza di assemblaggio sia corretta.

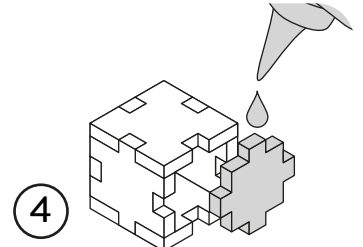

4

Once verified the correct assembly sequence, just add a small quantity of PVA glue on every joint.
Dopo aver verificato la sequenza di assemblaggio aggiungi una piccola quantità di colla vinilica su tutti gli incastri per garantirne la durata nel tempo.

INSTRUCTIONS

TRINITY SERIES

This tray series is designed to fit lots of different components, from tokens, to meeples, to other small sized pieces.

Questa serie di tray è progettata per ospitare un'infinita quantità di tipologie di pezzi, dai token, ai meeples, ad altri pezzi di piccole dimensioni.

TRINITY SMALL



3.5 x 4.9 x 3 cm

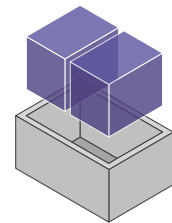

Dimension of each slot
Dimensioni di ogni alloggiamento

PZ-15 B

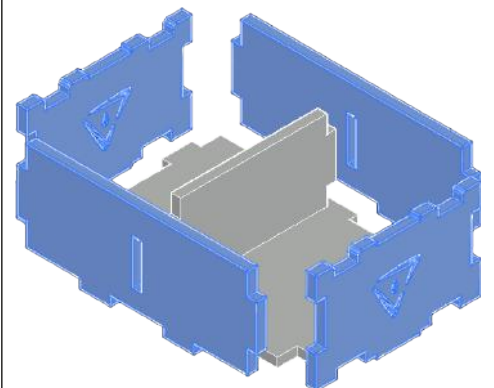
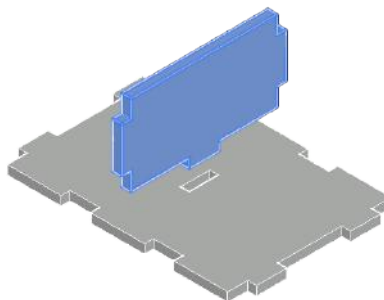
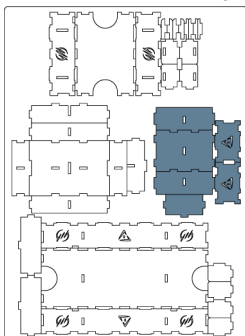

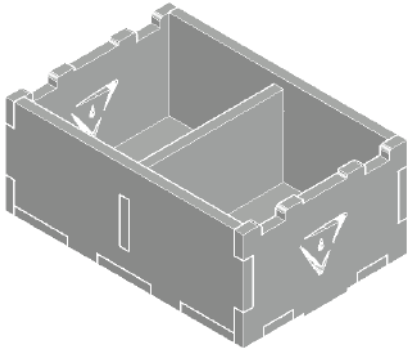

TRINITY MEDIUM



3.5 x 10.4 x 3 cm

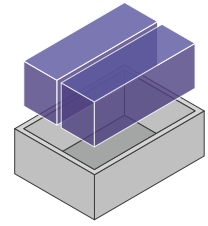

Dimension of each slot
Dimensioni di ogni alloggiamento

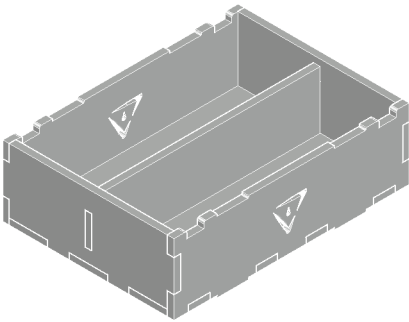
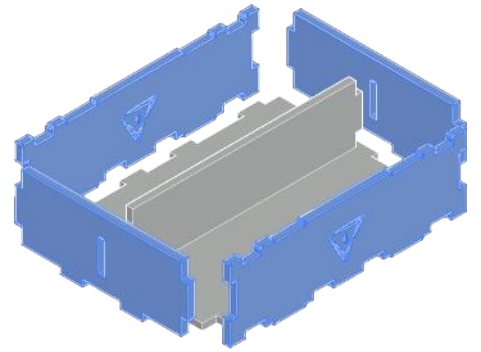
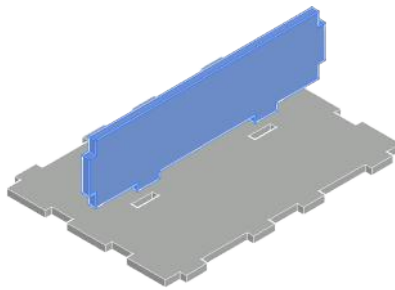
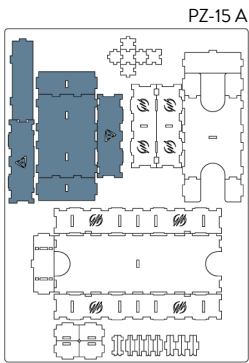

TRINITY LARGE



3.6 x 5 x 3 cm

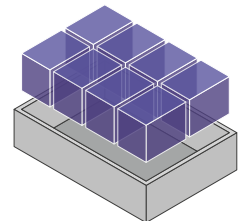

Dimension of each slot
Dimensioni di ogni alloggiamento

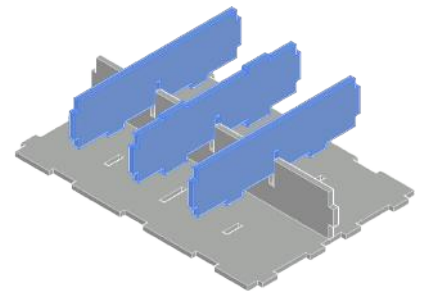
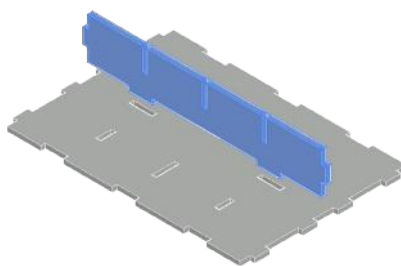
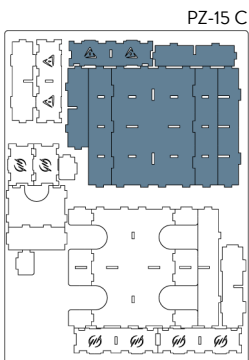

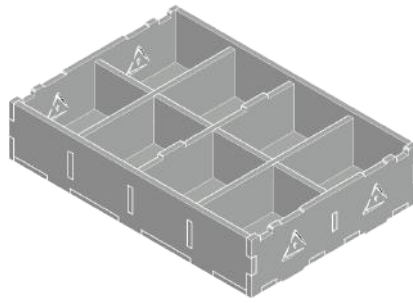
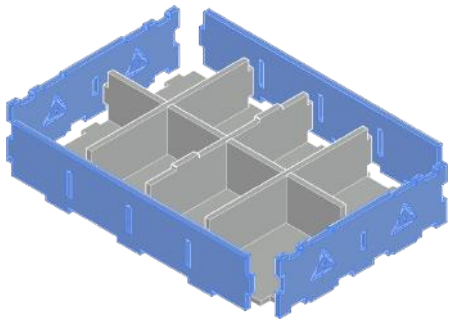

ITCH SERIES

This tray series is designed to fit small sized cards as well as big tokens or tiles.

Questa serie di contenitori è progettata per ospitare carte di piccole dimensioni, token di grandi dimensioni e tessere.

ITCH SMALL



7.4 x 4.9 x 3 cm

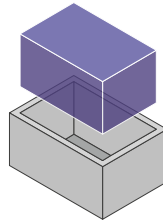

Slot dimension
Dimensioni alloggiamento

PZ-15 C

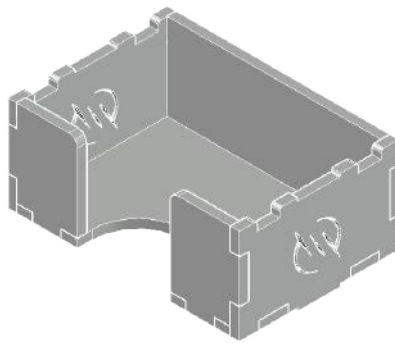
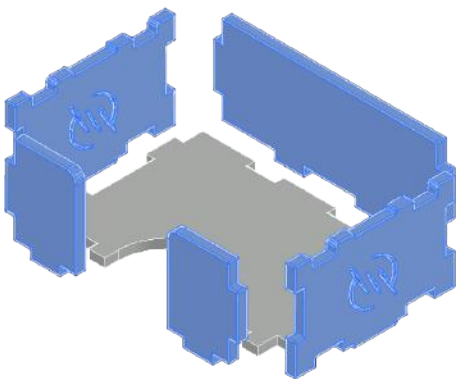
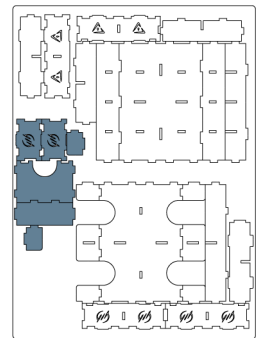

ITCH MEDIUM



7.4 x 5 x 3 cm

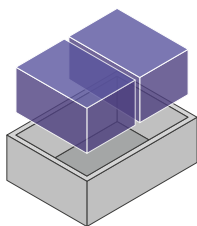

Dimension of each slot
Dimensioni di ogni alloggiamento

PZ-15 A

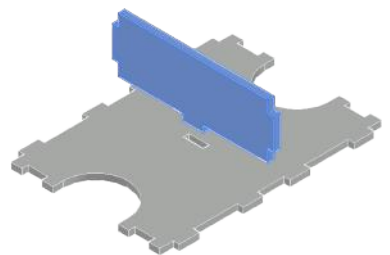
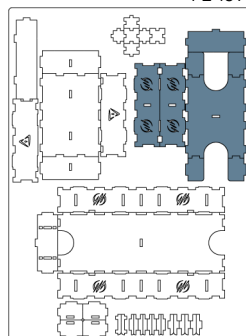

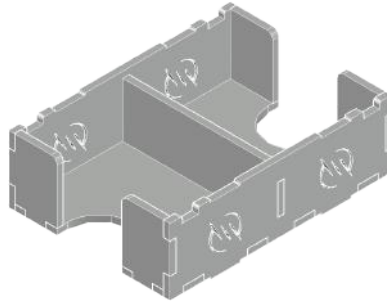
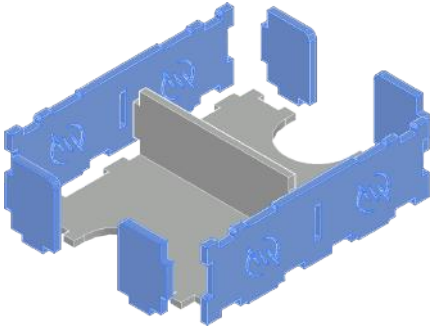

ITCH LARGE



7.5 x 5 x 3 cm

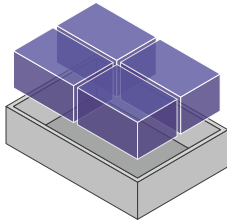

Dimension of each slot
Dimensioni di ogni alloggiamento

PZ-15 C

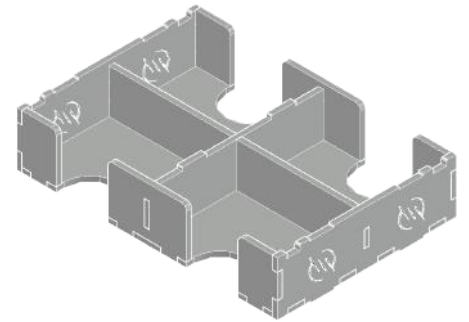
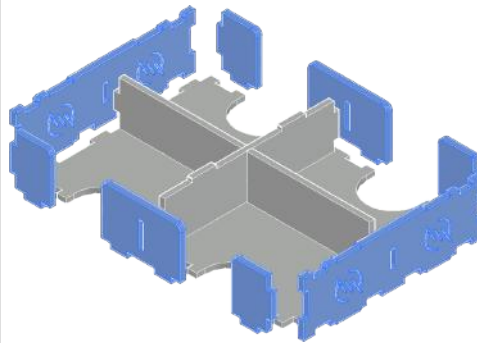
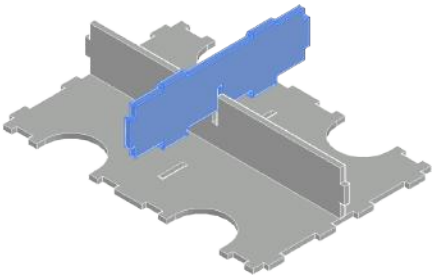
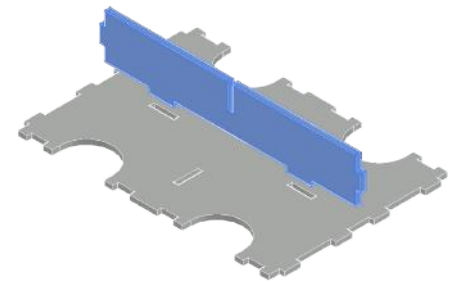
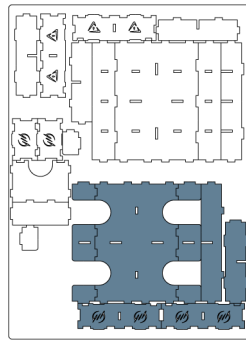

ITCH & TRINITY

Trinity is designed to fit lots of different components, from tokens, to meeples, to other small sized pieces. Itch is designed to fit small sized cards as well as big tokens or tiles. Trinity è progettata per ospitare un'infinita quantità di tipologie di pezzi, dai token, ai meeples, ad altri pezzi di piccole dimensioni. Itch è progettata per ospitare carte di piccole dimensioni, token di grandi dimensioni e tessere.

ITCH & TRINITY LONG



3.2 x 4.8 x 2.7 cm

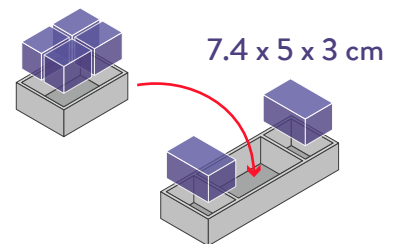

Dimension of each slot
Dimensioni di ogni alloggiamento

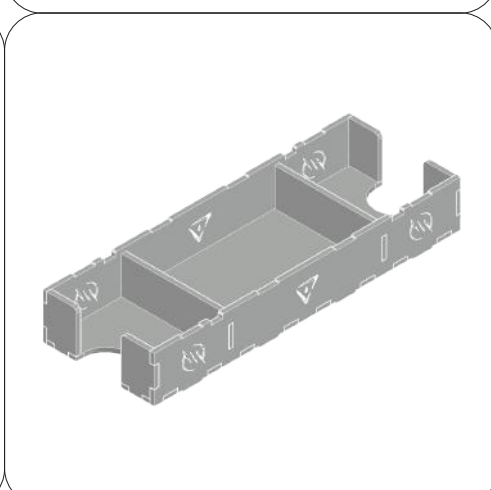
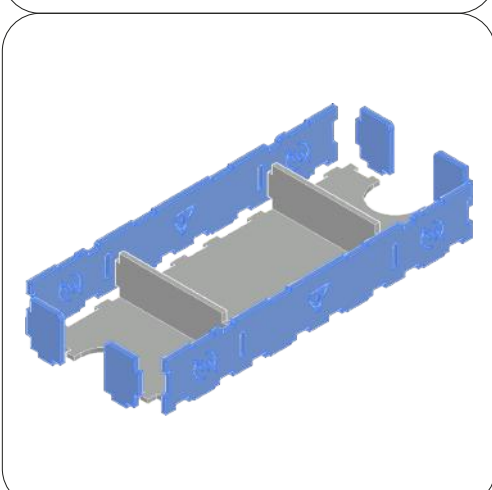
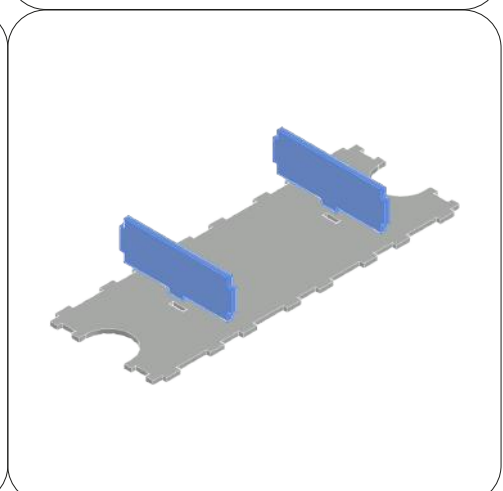
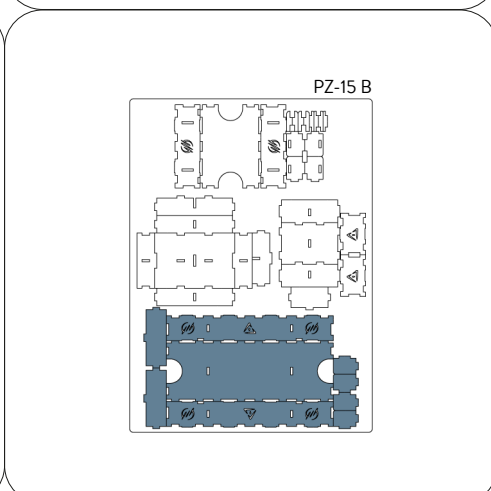
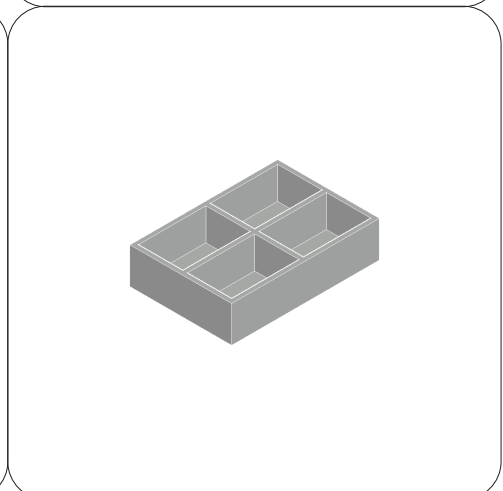
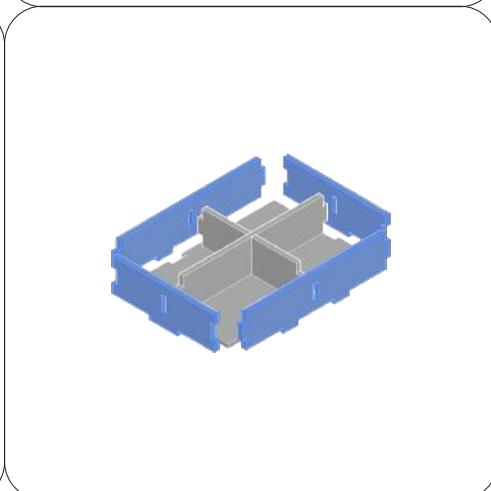
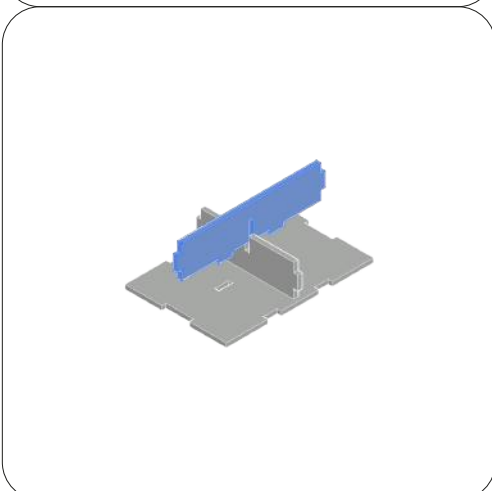
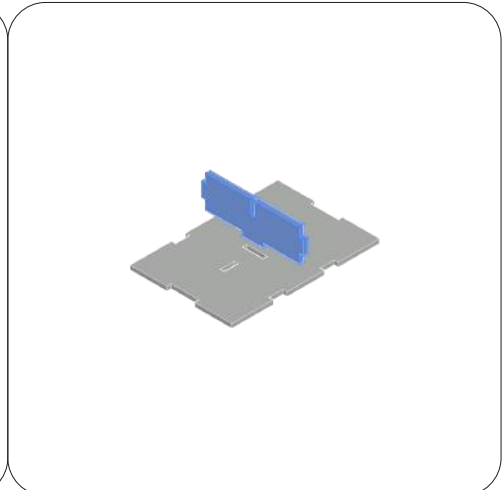
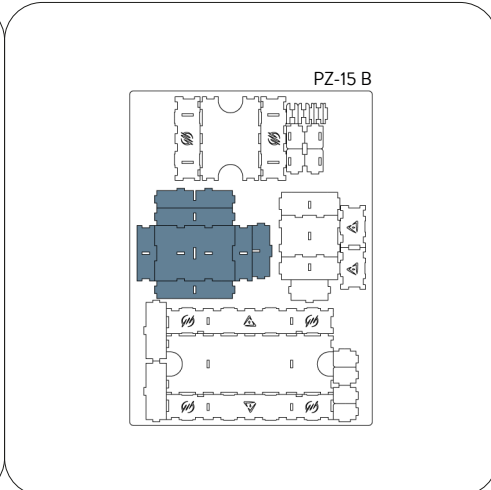

NOTE: Don't use glue on this joint; this piece can be removed during the game. Non usare colla su questo incastro, pezzo rimovibile durante il gioco.

SCRATCH SERIES

This tray series is designed to fit standard sized cards.

Questa serie di contenitori è progettata per ospitare carte di dimensioni standard.

SCRATCH MEDIUM

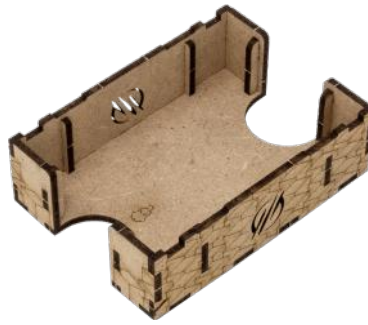

6.8 x 9.5 x 3 cm

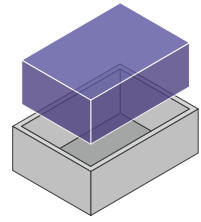

Slot dimension
Dimensioni alloggiamento

PZ-15 B

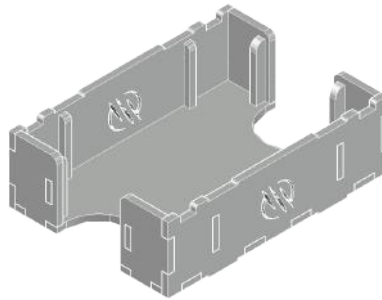
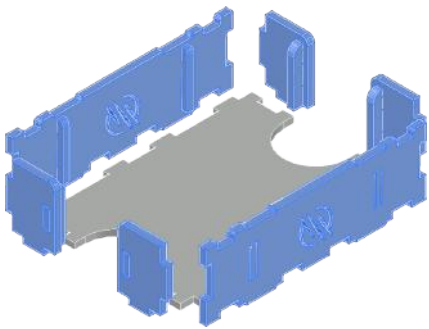
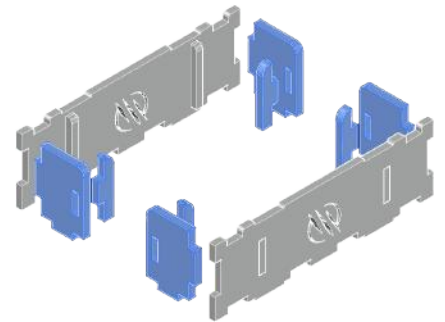
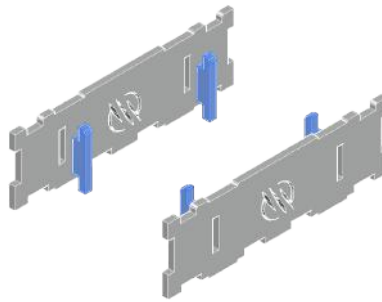
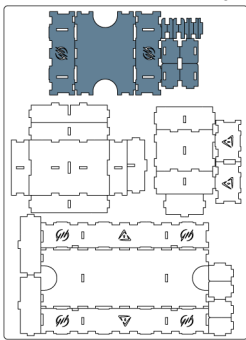

SCRATCH LONG

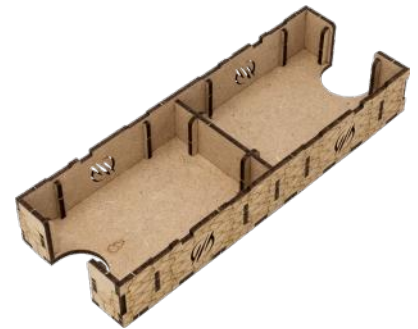

6.8 x 9.6 x 3 cm

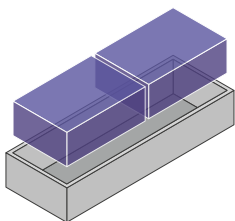

Dimension of each slot
Dimensioni di ogni alloggiamento

PZ-15 A

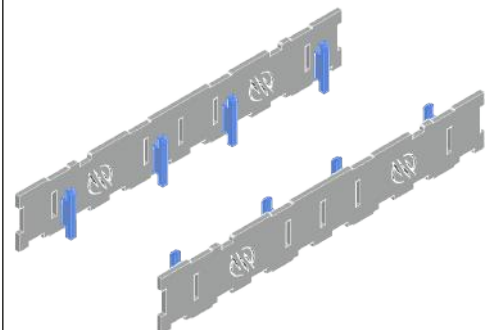
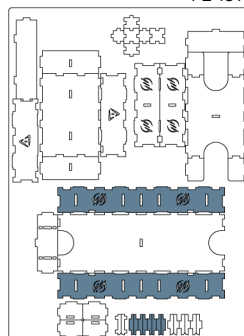

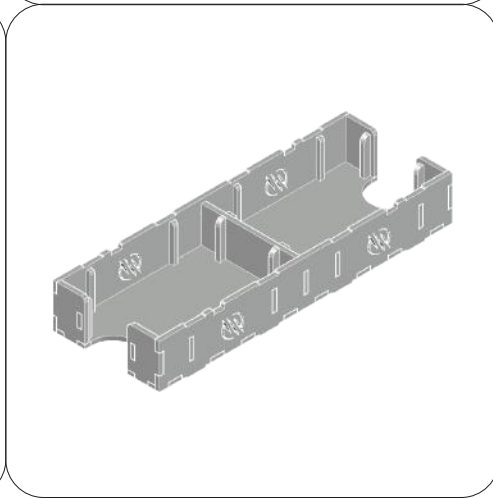
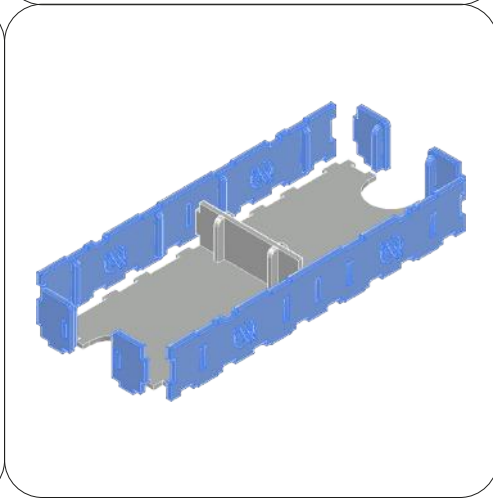
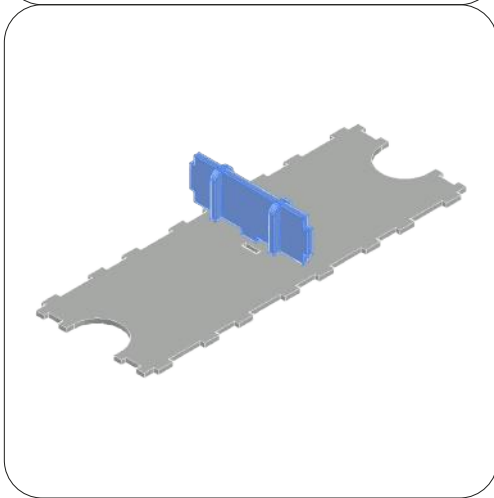
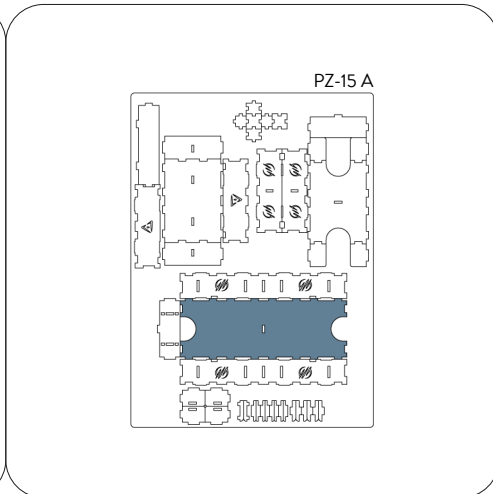
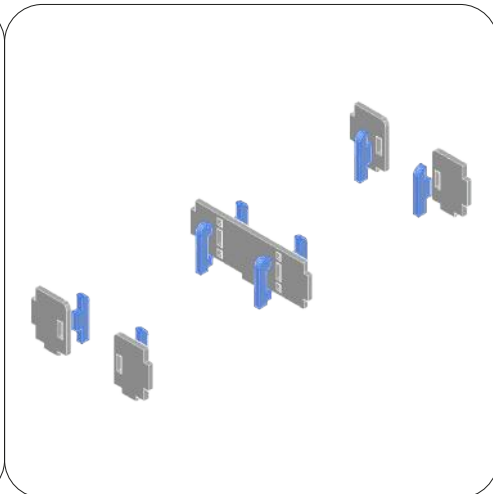
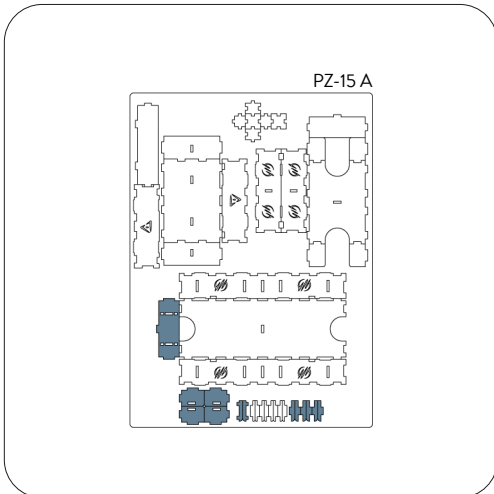

All trademarks and copyrights are the property of their respective owners.
 This product is not a toy. Contains small parts that can be swallowed or inhaled. 14+



Non-recyclable waste. Smaltire i materiali di scarto nell'indifferenziata.