

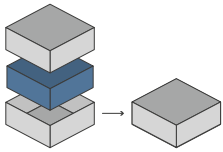

## ORGANIZER - COMPATIBLE WITH CAYLUS



Designed to fit into the game box; flush closure is guaranteed. Progettato per inserirsi all'interno della scatola del gioco; garantisce chiusura a filo\*

106 

Pieces to assemble  
Pezzi da assemblare

21.5 x 30.5 x 5.9 cm 

Size of assembled organiser  
Dimensioni organizer assemblato

### ORGANIZER CAPACITY

5x player set boxes, each with 3 housings; 1x resource box with 5 housings +1 for Bailiff and Provost pawns; 1x coin box, with 2 housings; 1x building tiles box. Specific space for each tile and arranged housings for better use and visibility during gameplay; 1x generic building tiles box.

5x scatoline con set giocatore, ognuna con 3 alloggiamenti; 1x portarisorsa, con 5 alloggiamenti + 1 alloggiamento per pedine Balivo e Prevosto; 1x portamonete, con 2 alloggiamenti; 1x contenitore tessere edifici: spazi singoli per ciascuna tessera e alloggiamenti studiati per avere il massimo colpo d'occhio durante il gioco; 1x contenitore edifici neutrali.



\* Any doubt?  
Check out our FAQ page or download the digital version of the instructions on our website!

All trademarks and copyrights are the property of their respective owners.  
This product is not a toy. Contains small parts that can be swallowed or inhaled. 14+

[thedigtroyers.com](http://thedigtroyers.com)  [/thedigtroyers](https://www.facebook.com/thedigtroyers)  [/thedigtroyers](https://www.instagram.com/thedigtroyers)  [info@thedigtroyers.com](mailto:info@thedigtroyers.com)





## ORGANIZER - COMPATIBLE WITH CAYLUS

### TUTORIAL - THE DICETROYERS DICE!

Among the pieces to assemble, you'll find a dice. This is not part of the organizer, but it can be a good starting point to practice!

Tra i materiali da assemblare troverai un dado. Questo componente non fa parte dell'organizer, né del gioco, ma è un ottimo punto di partenza per fare un po' di pratica.

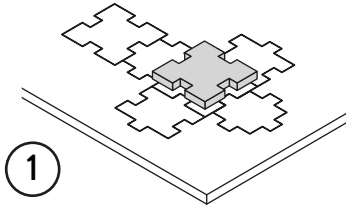

1

Gently take off  
all the pieces.  
Stacca delicatamente  
dal foglio tutti i pezzi.

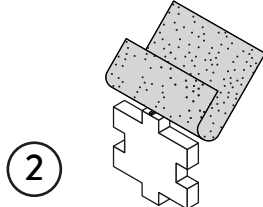

2

If necessary, use sand paper to  
smoothen the borders.  
Se necessario rifila con carta  
vetrata per legno eventuali  
imperfezioni dei pezzi.

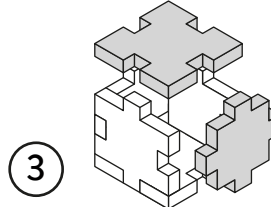

3

Get familiar with  
all the pieces  
and check the correct assembly  
sequence.  
Prendi familiarità con tutti  
i pezzi, per assicurarti  
che la sequenza di assemblaggio sia  
corretta.

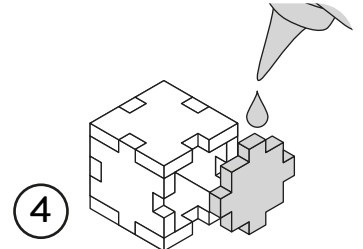

4

Once verified the correct assembly  
sequence, just add a small quantity  
of PVA glue on every joint.  
Dopo aver verificato  
la sequenza di assemblaggio  
aggiungi una piccola quantità di  
colla vinilica su tutti  
gli incastri per garantirne  
la durata nel tempo.

## INSTRUCTIONS

A

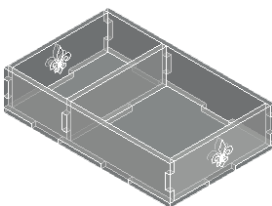
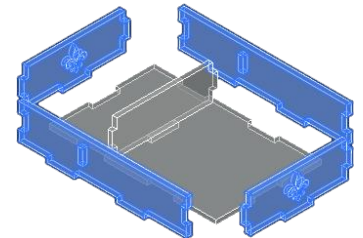
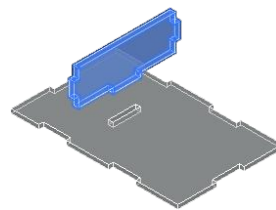
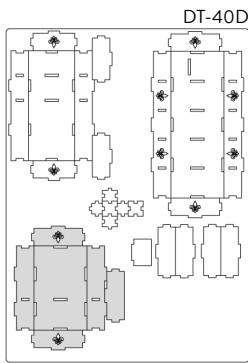

B

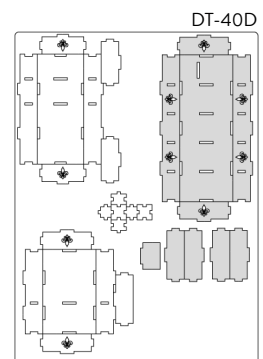

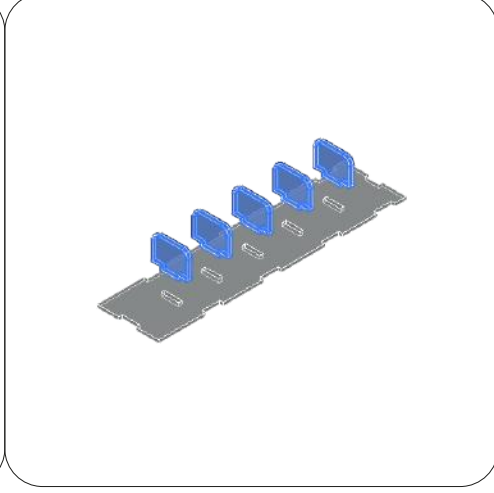
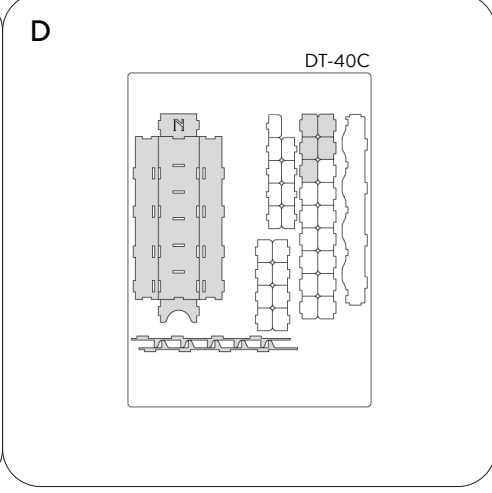
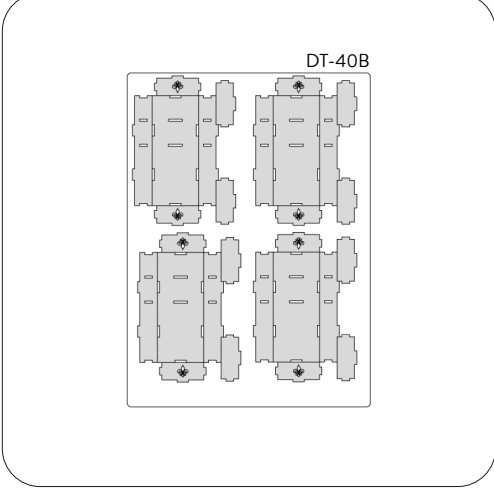
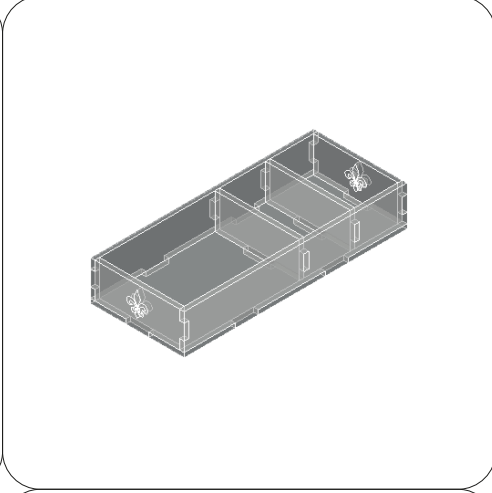
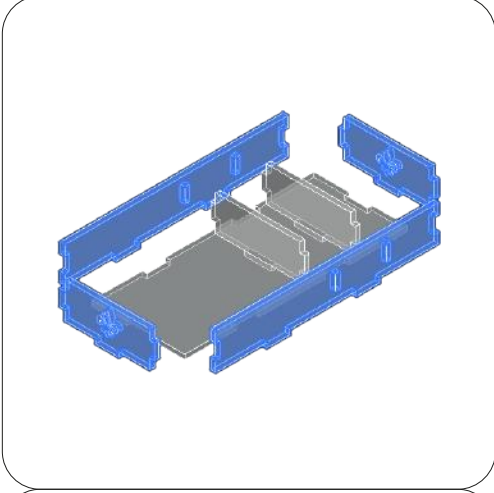
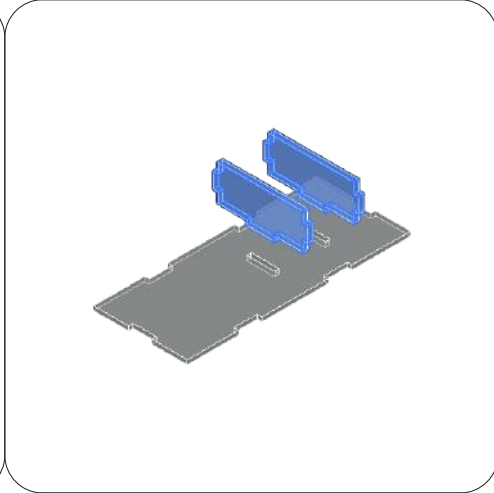
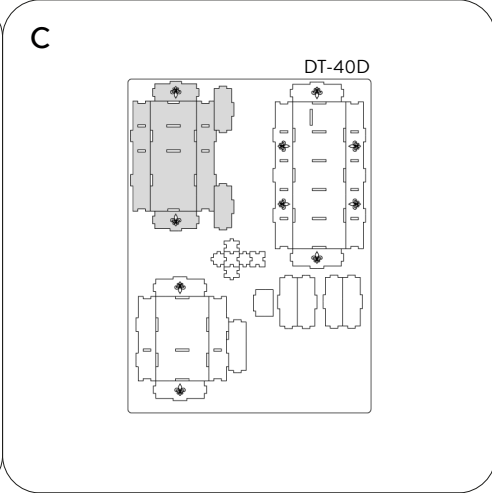
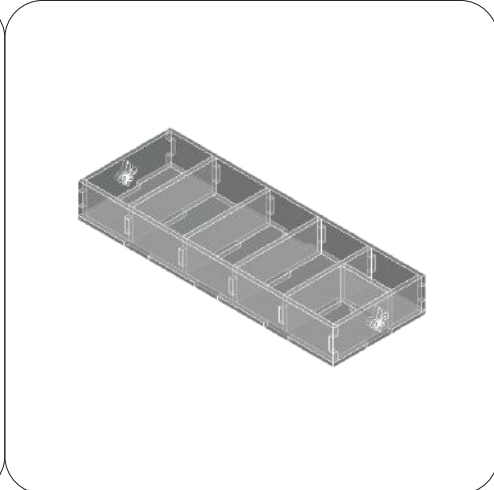
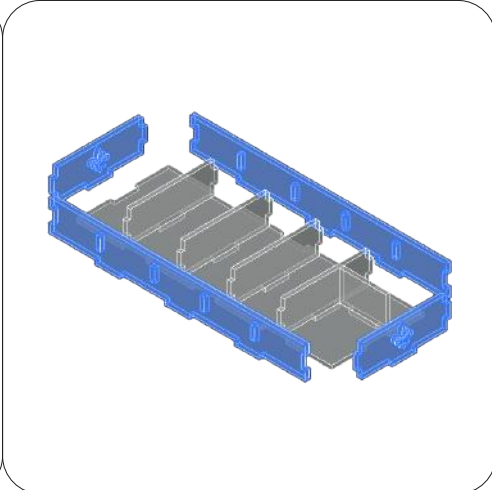
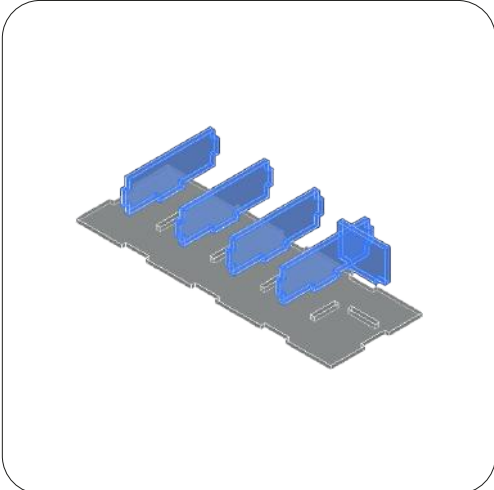

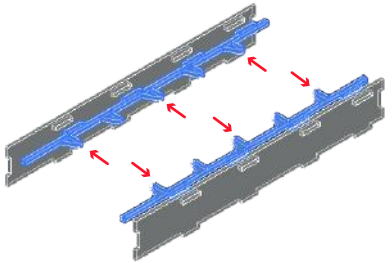

NOTE: The pieces highlighted in blue must have the engravings facing upwards.  
Assicurati che i pezzi evidenziati in blu abbiano le incisioni rivolte verso l'alto.

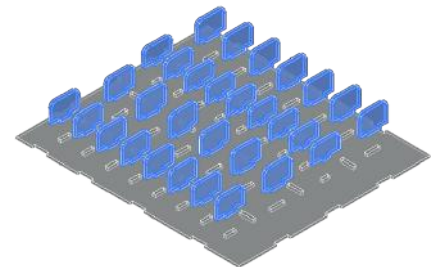
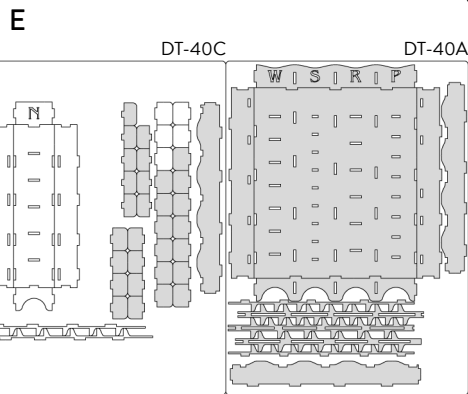
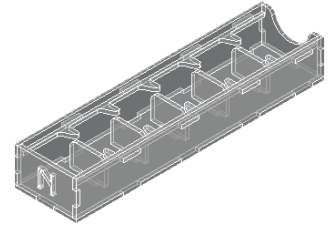
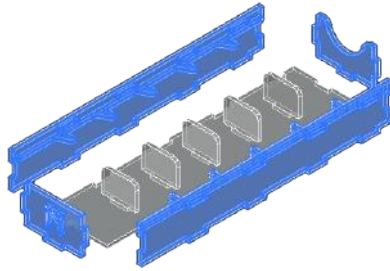

NOTE: Each row has a different joint size, pay attention to match them correctly. Ogni fila ha una dimensione di incastro differente, trova le corrette corrispondenze.

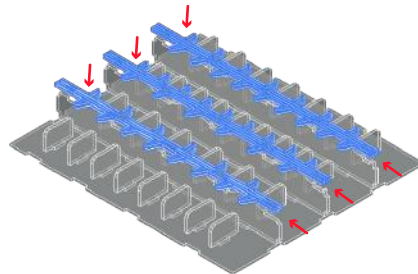
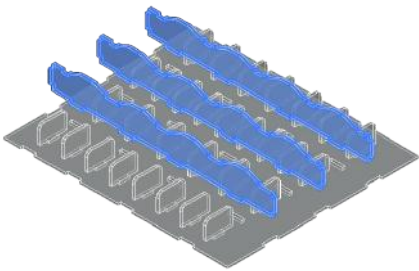

NOTE: The pieces highlighted in blue must have the engravings facing upwards. Each row has a different joint size, pay attention to match them correctly. Assicurati che i pezzi evidenziati in blu abbiano le incisioni rivolte verso l'alto. Ogni fila ha una dimensione di incastro differente, trova le corrette corrispondenze.

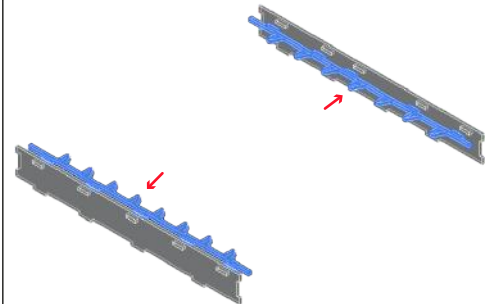

NOTE: The pieces highlighted in blue must have the engravings facing upwards. Assicurati che i pezzi evidenziati in blu abbiano le incisioni rivolte verso l'alto.

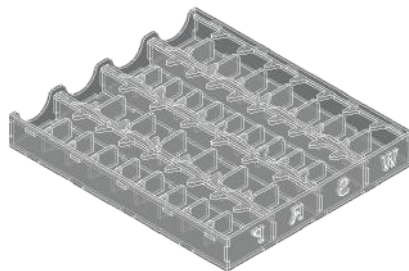
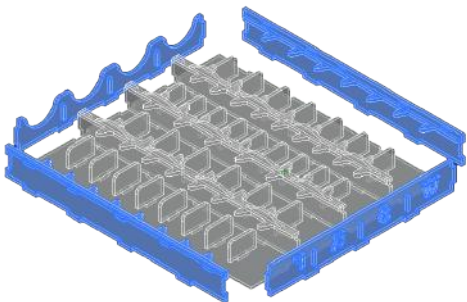

## REBOXING SEQUENCE!

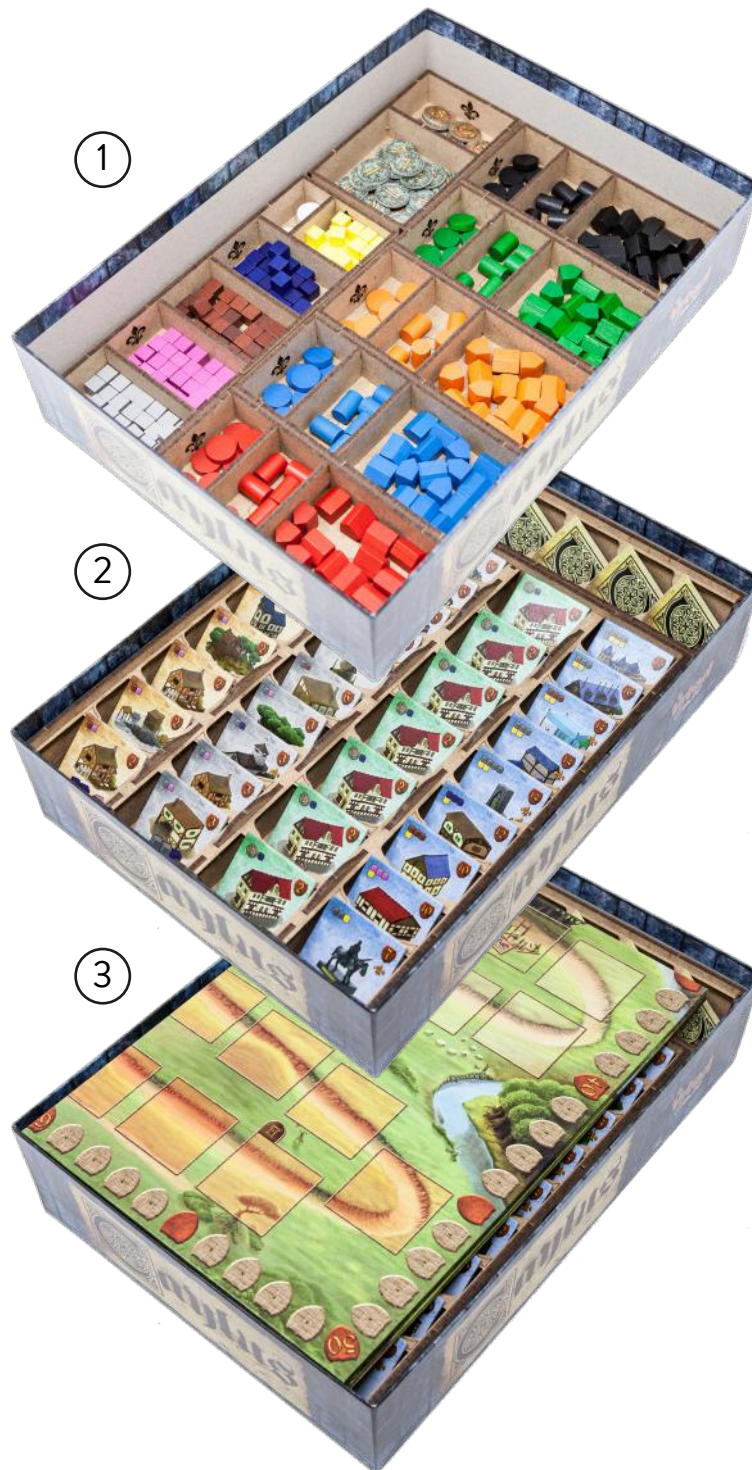

**VERTICAL  
STORAGE  
SAFETY**

Every piece will stay in its slot. Follow the reboxing sequence to properly store your organizer. We recommend using a h-band to avoid accidental box opening. Don't shake. Ogni componente rimarrà al suo posto.

Segui la sequenza di reinserimento per riporre nella maniera corretta il tuo organizer. Consigliamo l'utilizzo di una h-band per evitare aperture accidentali. Non scuotere.

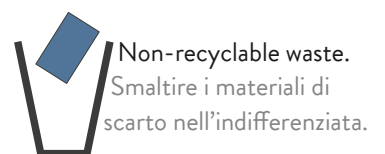

Non-recyclable waste.  
Smaltire i materiali di  
scarto nell'indifferenziata.

All trademarks and copyrights are the property of their respective owners.  
This product is not a toy. Contains small parts that can be swallowed or inhaled. 14+